

UNIWORLD[®]
BOUTIQUE RIVER CRUISES

THE FINEST LUXURY RIVER CRUISES

Setting sail in 2024 & 2025



— THE LUXURY —
NEW YEAR SALE EVENT
WITH SAVINGS OF UP TO £1,500^{PP}

Book by 31st January

2024 & 2025

DANUBE | RHINE | MAIN & MOSELLE | SAÔNE | RHÔNE
DORDOGNE | GARONNE | SEINE | DOURO | VENETIAN LAGOON
SPECTACULAR JOURNEYS OF THE WORLD

— *Second Edition* —

You Deserve the Best

For more than four decades, Uniworld has specialised in providing beautifully curated, one-of-a-kind journeys aboard our award-winning **Floating Boutique Hotels**. Our fleet of destination-inspired ships sails the rivers of Europe, Egypt, Southeast Asia, India, and Peru in all-inclusive luxury, and we would be honoured to welcome you on board.

I invite you to find your inspiration as you read through the pages of this brochure. We offer a range of experiences, from our more traditional cruises along the **Rhine, Main, and Danube**—offering up experiences both picturesque and historic; to indulgent voyages in **France, Italy, and Portugal**; and such extraordinary destinations as the **Peruvian Amazon Rainforest, the Sacred Ganges, the River Nile and the Mekong Delta**; there is truly something for everyone. Our long-haul packages, titled **“Spectacular Journeys of the World”** are a true showcase of luxury, with our teams expertly partnering our 8 day river cruises with stays in leading hotels & resorts, plus immersive small-group touring experiences, offering a unique way of visiting such destinations in luxury.

In 2024, our guests can travel farther and longer than ever with the most ambitious journey in the modern river cruising industry, our 55-day **Rivers of the World** cruise. Additionally, we have introduced a 25-day journey spanning the rivers of Europe, designed for those travellers who want to spend more time exploring the world, whilst enjoying the luxury of added time in more destinations than ever.

The excitement continues with the addition of two beautiful Super Ships to our fleet. **S.S. Victoria** will join in 2024, and **S.S. Elisabeth** in 2025 - both will bring contemporary luxury and the largest suites to the rivers of Europe. You can join the S.S. Victoria on her inaugural season, where she will sail as many as four Uniworld itineraries. However, space is filling up quickly, as the launch of these sailings has proven to be incredibly popular.

As we look ahead to 2025, we have several new itineraries, including the 15-day **Rhine, Moselle & Belgium Grand Discovery**, an 11-day **Dutch & Belgian Holiday Celebration** for the winter, and an 18-day combination of our Bordeaux and Portugal itineraries, **Wine Roads of France & Portugal**. Although these itineraries don't feature in this edition, you can learn all about these new sailings on our website or by contacting your preferred travel agent.

In whichever way you choose to explore the world, do it in the unparalleled style of Uniworld. After all, **you deserve the best.**

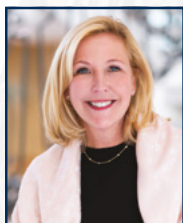

Warmest regards,

Ellen Bettridge

ELLEN BETTRIDGE

CEO
UNIWORLD BOUTIQUE RIVER CRUISES



TABLE OF CONTENTS

<i>The Uniworld Experience</i>		<i>Pages</i>
Introducing the newest addition to our fleet		4-5
360° Destination Immersion		6-7
A Unique Approach to River Cruising		8-9
Destination Inspired Ships		10-11
Meet our Bordeaux Inspired Super Ship		12-13
Suites Brimming with Personality		14-15
Exceptional Culinary Experiences		16-17
Regionally Inspired Culinary Options		18-19
A Legacy of Outstanding Service		20-21
VIP Shore Experiences		22-23
Unforgettable Evenings with Uniworld		24-25
Peace of Mind Travel		26
A Passion For Sustainable Tourism		27
Insights from our Incredible Past Guests		28-29
The Most All-Inclusive Amenities		30-31
<i>Discover Europe's Waterways</i>		<i>Pages</i>
Castles Along the Rhine		32-33
Magnificent Moselle & Rhine		34-35
Venice & the Jewels of Veneto		36-37
Douro River Valley		38-39
Brilliant Bordeaux		40-41
Burgundy & Provence		42-43
Paris & Normandy		44-45
Enchanting Danube		46-47
Highlights of Eastern Europe		48-49
<i>Spectacular Journeys of the World</i>		<i>Pages</i>
Our Spectacular Journeys of the World		52-53
Sail in the Ultimate Style		54-55
Stay in the World's Finest Hotels		56-57
Luxury Rail & Cruise Journeys		58-61
Timeless Wonders of Vietnam, Cambodia & the Mekong		62-67
India's Golden Triangle & the Sacred Ganges		68-73
Splendours of Egypt & the Nile		74-79
Peruvian Amazon & Machu Picchu Luxury Expedition		80-85
<i>Meet our Fleet of Ships</i>		<i>Pages</i>
Deck Plans		86-101

Introducing the newest addition to our fleet in 2024

SUPER SHIP VICTORIA

We're thrilled to share the exciting news that the S.S. *Victoria* joins our European fleet in 2024, further elevating Uniworld's collection of ships to unparalleled heights. With an ambiance of contemporary luxury, she embodies our commitment to delivering the highest level of luxury wherever we sail.

In her inaugural season, the S.S. *Victoria* will offer four unique Uniworld sailings throughout 2024 along the Rhine River. This addition not only brings the largest suites in European river cruising but also cements our status as the world's premier luxury river cruise line. You can sail on the following itineraries in 2024:

Holland & Belgium at Tulip Time

From Brussels to Amsterdam
Four departures from March to April

Magnificent Moselle & Rhine

From Frankfurt to Frankfurt
Seven departures from June to August

Castles Along the Rhine

From Basel to Amsterdam
Ten departures from September to October

Belgian Holiday Markets

From Brussels to Brussels
Four departures from November to December

See pages 32-35



360° DESTINATION IMMERSION

Explore the world's rivers in the ultimate style

Immerse yourself in the destinations you sail through with Uniworld. Every element—from the ship you sail on and the culinary options you enjoy, to the carefully curated on-shore experiences—is designed to provide a fully immersive journey. We proudly offer our guests the most immersive journey possible both on the river and through the countries we sail, and of course in the most luxurious way possible.

SHIPS DESIGNED SPECIFICALLY FOR EACH RIVER

Uniworld meticulously designs ships to complement each river, embracing local themes with exquisite craftsmanship. In Northern Italy, experience Venetian allure. On the Mekong, our ship echoes the charm of the Raffles Hotel on water. Discover the perfect fusion of destination and design, creating unforgettable river cruise experiences.



EXCEPTIONAL LOCALLY INSPIRED CUISINE

Embark on a culinary adventure as you savour the diverse flavours of your destination. Our onboard venues showcase true local menus, from charming brasseries to authentic pizzerias. Experience the region's finest seasonal ingredients, expertly prepared and paired with locally sourced wines by our sommelier. Indulge in exceptional cuisine, immersing yourself in unforgettable gastronomic delights.

IMMERSIVE AND LOCAL OFF BOARD EXPERIENCES

Embark on extraordinary excursions with Uniworld. Say goodbye to queuing and indulge in exclusive, money-can't-buy adventures. Choose from daily included excursions, uncovering local gems and meeting passionate owners. Even in bustling places, we prioritise your experience to offer a queue-free visit. Experience Venice's St. Mark's Basilica crowd-free or witness the Taj Mahal at sunrise before anyone else arrives.



THE BEST SERVICE ON THE WORLD'S RIVERS

Our award-winning onboard team plays a vital role in enhancing your experience. With an impressive average tenure of 9 years, our team members are dedicated to providing exceptional service. From personalised interactions to fostering camaraderie, our team ensures an unforgettable adventure filled with fun and genuine connections.



SAIL THROUGH EXCEPTIONAL LOCATIONS

There is no finer way to experience the essence of a destination than by gracefully sailing through its heart. Unlike ocean cruises, you'll be experiencing the culture of your destination within minutes and can step ashore throughout the day.



IMMERSIVE EVENING ENTERTAINMENT

Experience enchantment both onboard and beyond with our captivating entertainment. As the sun sets, our ships come alive with live performances by talented artists and themed events. Step ashore for included excursions and immerse yourself in the local nightlife scene. From local acts to incredible singers and bands, our entertainment will leave you spellbound. Your holiday is a celebration of fun and unforgettable moments.



*Certain inclusions may vary from itinerary to itinerary.



A UNIQUE APPROACH TO RIVER CRUISING

Understanding the story behind our floating boutique hotels

Uniworld's story is unique within the river cruise industry. From modest beginnings as one small hotel in South Africa, we have evolved into a global consortium of luxury boutique hotels, famously known as *The Red Carnation Hotel Collection*. Being the sister brand to this successful entity has empowered us to draw on their century's worth of knowledge and experience, enabling us to provide the most exquisite luxury river cruises in the industry.

OUR DNA

Rooted in our hotelier heritage, we are deeply committed to providing industry-leading service. Our river cruises are meticulously designed not just to transport you to stunning destinations, but to immerse you in them with exceptional care. Every Uniworld team member embodies our guiding principle: *"No request is too large, no detail too small."*

This dedication ensures an extraordinary experience from the moment you make your booking to the warm welcome aboard any of our ships.

DRIVEN BY OUR FOUNDER, MRS. BEATRICE TOLLMAN

The heart and soul of Uniworld's distinctive approach is our founder, *Mrs. Beatrice Tollman*. A celebrated chef and honorary member of the British Travel and Hospitality Hall of Fame, Beatrice acquired Uniworld in 2004, driven by her vision to establish the world's premier luxury river cruise line.

Her personal touch resonates throughout our fleet – from the bespoke service to the locally inspired cuisine, ensuring every journey with Uniworld is a testament to her unique vision and commitment to excellence.

SHIPS INSPIRED

*by the destinations
they sail through*

We take pride in being the only river cruise line that seamlessly blends the inspiration of our ship designs with the captivating destinations we sail through. Each of our meticulously crafted vessels reflects the distinctive charm and character of its surroundings, setting a new standard of luxury and elegance in the cruise industry.

A HOST OF BREATHTAKING ORIGINAL ARTWORK

Step aboard and be captivated by the onboard artwork, exquisite colour patterns, and meticulous finishings that create an atmosphere of ultra-luxury. Our ships serve as floating galleries, adorned with stunning original artwork that showcases the rich cultural heritage of the regions we visit. Step into a world where masterpieces come to life as you encounter renowned works by celebrated artists like *Pablo Picasso, Joan Miró, Henri Matisse, and Marc Chagall*.

A TRUE SENSE OF PURPOSE ONBOARD

Uniworld's ships are crafted to deliver a boutique hotel experience on the world's rivers, blending exceptional amenities with destination-specific sophistication. From the Parisian chic of our vessels sailing from Paris to the elegance of a Raffles-style ambiance on the Mekong, each journey is a testament to luxury.

EXCEPTIONAL ONBOARD COMFORT

Whilst you're travelling onboard our ships, you'll enjoy the comforts of renowned *Savoir®* beds of England. These multi-award-winning mattresses are crafted for unparalleled comfort and luxury, ensuring our guests enjoy restful sleep and exceptional relaxation throughout their journey. After a day of breathtaking sights and cultural immersion, retreat to the sumptuous embrace of a *Savoir®* bed, an oasis of comfort on the world's rivers.



ONE-OF-A-KIND SHIPS

inspired by their destinations

Here's a prime example of why each of our Super Ships stands out from the rest in the industry, and why they are the perfect choice for an unforgettable luxury adventure. Take the *S.S. Bon Voyage*, designed specifically for sailing through the picturesque summer landscapes of Southwest France. This extraordinary ship boasts a stunning Soleil deck, complete with a large canopy and comfortable seating, making it the ultimate spot to watch the passing vineyards and chateaux as you cruise along the river. On the spacious top deck, you'll also find an inviting infinity pool, further enhancing the relaxation and enjoyment of your journey.

Super Ship Bon Voyage Quick Facts

124

GUESTS

50

STAFF

4

REGIONAL RESTAURANTS

2019

INAUGURAL SEASON

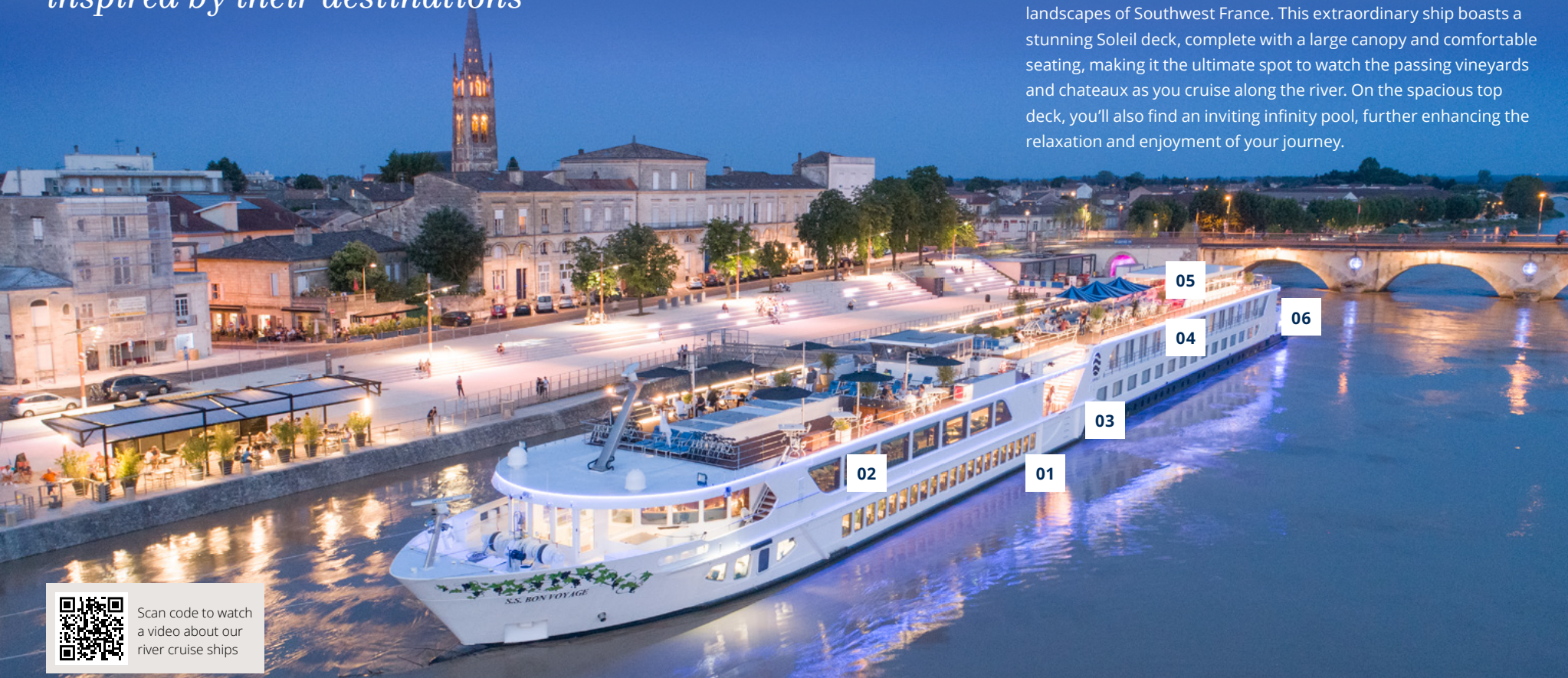

Scan code to watch a video about our river cruise ships

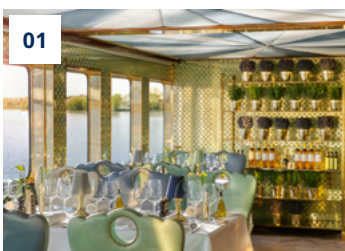

01

LE GRAND FROMAGE

At Le Grand Fromage, the menu is designed to reflect the local cuisine of the destinations the ship is sailing through. It's the perfect location whether you're looking to try traditional local dishes or simply enjoy a delicious meal.



02

SALON CHAMPAGNE

The stylish emerald tones used to decorate this venue were inspired by Yves Saint Laurent's personal abode, Villa Majorelle. Here, guests can enjoy unlimited drinks including fine wines and handmade cocktails.



03

LE CAVE DES VINS

La Cave des Vins is an intimate space where connoisseurs can gather for expert food and wine pairing dinners upon request. It's the perfect venue to embark on a culinary journey with your newfound travel companions.



04

SUITES & STATEROOMS

In addition to the public spaces, the *S.S. Bon Voyage* features three decks of staterooms, ranging from our entry-level Classic cabins to our one-of-a-kind Grand Suites.



05

LE CAFE DU SOLEIL

Poolside service at Le Café du Soleil offers casual French cuisine, as well as open-air cooking demonstrations from our chefs. You can even enjoy a wine and painting art workshop as you sail.

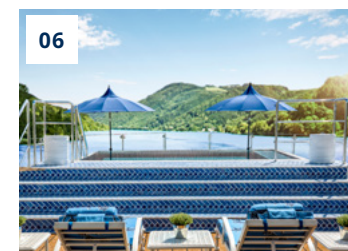

06

SOLEIL DECK

Enjoy the passing surroundings as you sail through the region of Bordeaux. Awash with vibrant fabrics, comfortable seating, and an infinity pool overlooking the French countryside, this area is likely to be your favourite onboard.



Suite, S/S. La Venezia



Scan code to watch a video about our suites

SUITES BRIMMING WITH

their own distinct personalities

ONE-OF-A-KIND DESIGN

Like our ships, no two suites in our fleet are the same. Each suite is uniquely designed, complete with custom colour patterns and original artwork throughout, making for a truly unforgettable experience.

THOUGHTFUL PERSONAL TOUCHES

Each suite is truly a showstopper, boasting custom fabrics and upholstery, original artwork, handcrafted furniture, and Savoir® Beds of England.

BUTLER SERVICE*

Every European suite comes complete with your own Butler, providing exemplary service around the clock, including packing and unpacking services, room service, and more. Unlike many other river cruise lines, our Butlers don't assume other roles on the ship, allowing them to fully focus on delivering great service to you without any distractions.

MORE SPACE

Our suites feature more room to roam, often with living areas, spacious bedrooms, and larger bathrooms equipped with double sinks, tubs, and marble tiles.

FULLY STOCKED BAR

In addition to a bottle of wine upon arrival, our in-suite mini-bars are filled with a selection of drinks. You'll also have a crystal carafe that can be refilled daily as you please, from a selection of brandy, whiskey, and vodka.

FRESH COOKIES & FRUIT PLATE DELIVERED DAILY

What makes your suite feel like home? It's all in the *Tiny Noticeable Touches*-such as a fresh fruit plate and a selection of cookies left in your room every day, courtesy of our pastry chef.

LIMITED AVAILABILITY

With just a small number of suites per ship, these are the fastest cabin type to sell out across our fleet.

*Butler service not available in Peru, Egypt and India. Suite amenities vary by ship.



EXCEPTIONAL CULINARY EXPERIENCES

*Embark on a Culinary
Voyage like no other*

With the Uniworld experience being incredibly unique, you can expect nothing less from the cuisine you will enjoy onboard. Experience the essence of each region through our ever-evolving menus, crafted with fresh, seasonal ingredients that change throughout the season.

From the very first bite, you'll understand why Uniworld is renowned worldwide for offering extraordinary dining experiences.

DINING PAIRED WITH THE FINEST WINES

Our onboard sommelier, a true connoisseur of fine wines, curates an exceptional selection from the vineyards that line the riverbanks you sail past. Before each dinner, indulge in a captivating presentation as the sommelier unveils the flavours of the region that you'll be enjoying that evening, pouring wines that beautifully complement the delectable dishes prepared by our talented chefs.

PROUD TO WEAR THE CREST

Uniworld takes immense pride in being a part of the *Chaine des Rôtisseurs*, an esteemed international gastronomic society dedicated to fine dining and culinary excellence. As a member, we uphold the highest standards of culinary craftsmanship, ensuring that every meal you enjoy aboard our ships is a masterpiece of flavour and presentation.

Immerse yourself in a world of culinary delights where each bite is a testament to our unwavering commitment to exceptional quality.



REGIONALLY INSPIRED CULINARY OPTIONS

Enjoy a taste of your destinations

We believe that one of the best ways to truly immerse yourself in the destinations you sail through is through their culinary traditions. Our culinary approach is simple yet profound: we aim to serve the authentic flavours and delicacies of the regions you visit, bringing the essence of each destination to your plate. Indulge in a delightful journey of tastes and aromas, as our onboard dining experiences take you on a gastronomic adventure like no other. Prepare to embark on a culinary journey where every meal tells a story, and every bite unveils the essence of the regions you sail through. **Bon appétit!**



Dine in locally inspired venues

Our Super Ships offer a range of dining options inspired by the destinations you visit. From delightful brasseries to elegant restaurants and chef's table experiences, we have carefully designed alternative dining venues that showcase local cuisine. Below is an example of the varied dining experiences available to those guests sailing through Paris and northern France onboard the Super Ship *Joie de Vivre*.



LE BISTROT

The ship's very own Parisian-style café serves classic French cuisine. Designed with windows that lower for an open-air ambiance, Le Bistrot is a très bon spot to savour wrap-around views of the Seine.



LE RESTAURANT PIGALLE

Le Restaurant Pigalle offers menus reflective of the local cuisine, prepared from locally-sourced ingredients. Imagine yourself dining in the finest Parisian restaurant every night.



LA CAVE DES VINS

Experience an exclusive epicurean event in our onboard show kitchen. Under the guidance of Uniworld's talented chefs, prepare an exquisite seven-course meal. Relish wine pairings designed just for you by our Sommelier.



A LEGACY OF OUTSTANDING SERVICE

on the World's Rivers

We go above and beyond to provide industry-leading service, delivered by our extraordinary crew. We often hear from our guests that the service they receive throughout their travels with Uniworld is the reason they return time and time again. Many compare the service they received to that of leading ocean cruise lines and world-renowned hotels.

By implementing an environment for our crew to feel valued and appreciated, they choose to return to stay with us year after year, boasting an impressive retention rate of over 90% for the past 15 years. Their passion and commitment shine through in the exceptional service they provide, creating unforgettable journeys for every guest.



“The warm service you receive when travelling with us creates a feeling that stays with you long after your journey ends”

- Ellen Bettridge, Uniworld CEO & President

CELEBRATING OUR CREW'S SUCCESS

At the beginning of every season, we host our annual pre-season conference where we bring hundreds of our crew members together and invite them to stay on up to five of our ships. It's a time for our crew to bond, enjoy the ship amenities, and prepare for the upcoming season. The highlight of this conference is the glamorous awards gala, where we honour and applaud the outstanding achievements of our crew. From awarding the best housekeepers to sommeliers, these awards serve as a testament to their dedication and expertise.

BRING EVERY DESTINATION TO LIFE

*With a personalised choice
of immersive shore excursions*

Every Uniworld cruise is meticulously designed to offer an experience unmatched anywhere else, replete with breathtaking moments at every turn. We go the extra mile to ensure our included and optional excursions immerse you in the authentic culture, vistas, and culinary delights of the regions you visit.



Head to a local Vineyard for private wine tasting



EXPLORE YOUR OWN WAY

At Uniworld, we understand that every guest has unique interests and preferences. That's why we offer flexible shore excursions tailored to a broad spectrum of tastes and passions. Whether you're drawn to art, history, gastronomy, or cultural immersion, we empower you to choose how you explore each destination during your cruise. Our aim is to provide not just a journey, but a personalised adventure that resonates with your sense of discovery and adventure.



RED CARPET MOMENTS

Certain experiences become cherished memories, etched in our minds forever. Our red carpet moments offer such indelible moments with once-in-a-lifetime opportunities arranged exclusively for our guests. Visit *St. Mark's Basilica* after hours, witness the sunrise over the *Taj Mahal*, or attend the *Vienna Art History Museum (Kunsthistorisches)* before it opens to the public. These experiences are priceless and often exclusively available to Uniworld guests.



EXCEPTIONAL NIGHTS OUT

Our latest excursion offerings go beyond the ordinary, featuring exclusive after-hours tours of renowned attractions and distinctive nightlife experiences. Highly popular among our guests, these unique experiences often become the highlight of their journey, creating cherished memories that last long after the cruise has ended. By offering these exceptional outings, we aim to enrich your travel experience and showcase the exceptional locations you are visiting.

*With our premium all-inclusive offering, we include
multiple shore excursions for our guests to enjoy every day*

UNFORGETTABLE EVENINGS WITH UNIWORLD

Step Into a World of Evening Delight

Evenings with Uniworld are not merely an extension of the day but an integral and lively aspect of your journey. We have thoughtfully curated an impressive array of onboard and onshore evening entertainment to make your nights as enchanting as your days. Plus, our exclusive docking locations in city centres ensures you have the freedom to explore your mesmerising surroundings as you please.

ONBOARD ENTERTAINMENT

Immerse yourself in a world of enchanting onboard entertainment. On select evenings, our performances will transport you to the core of the local culture. From the captivating Can-Can dance in France to the soulful tunes of talented local singers and bands, our entertainment options are meticulously crafted for your utmost enjoyment.

NIGHT'S OUT EXCURSIONS

Our immersive nights out excursions unveil the illuminated splendours of remarkable destinations. Picture participating in a private lighting ceremony at St. Mark's Basilica in Venice or revelling in the timeless masterpieces of *Mozart* and *Strauss* at a private concert in Vienna. These are just snapshots of the incredible experiences in store for you. With night's out options available on many of our European itineraries, you'll have an array of captivating excursions at your disposal.



*Private lighting ceremony in
the heart of St. Mark's Basilica*



INTIMATE ALTERNATIVE VENUES ONBOARD

For those seeking an alternative to the mainstream onboard entertainment, our Super Ships offer varied options. Unwind in our cosy bars or immerse yourself in the charm of our classic onboard cinemas. We provide the ideal spaces for a tranquil and restful evening onboard.

*Cinemas and alternate bars only available on select Super Ships. Entertainment not available every evening and may vary.

PEACE OF MIND TRAVEL

Embark on Your Voyage with Ease

At Uniworld, we appreciate that the journey to your dream cruise is as important as the destination itself. We're committed to exceeding expectations, crafting a travel experience that's nothing short of exceptional. Every segment of your journey should be masterfully orchestrated and flawlessly executed, which is why we offer a comprehensive travel service catering to each step of your adventure.



A PASSION FOR SUSTAINABLE TOURISM

and a penchant for giving back

As part of our dedication to sustainability, we focus on making a positive impact and advocating for environmental, social and economic responsibility under the guidance of Uniworld's Sustainability Officer, Julie Higgins.



EFFORTLESS JOURNEYS, PERFECTLY PLANNED

When you choose Uniworld, you're opting for relaxation and ease, trusting our expert team to handle the fine details. From the instant you book your cruise, our dedicated professionals are at your service to plan and coordinate your travel arrangements, ensuring a seamless and stress-free voyage. Whether by air or rail, we've got you covered. We meticulously arrange your flights or train connections, handpicking the most convenient routes and schedules to align with your needs. Rest assured, your journey to our ship will be smooth, effortless, and tailored just for you.



CLIMATE ACTION

We've become the only cruise line to join Path2Zero, a research project aimed at reaching net-zero carbon emissions in Europe. We're contributing financial support, advice, and the expertise of our captains and engineers, who are helping test real-world solutions in the program's "Living Labs."

FOOD WASTE

Over the last couple of years, we've piloted a comprehensive food waste measurement and reduction system known as **Leanpath** on a select few ships. In 2022 alone, food waste was reduced by 34% across 6 Uniworld ships, equating to 24,169 meals saved. In 2023, we expanded the program to every ship we own!

ELIMINATING PLASTIC

We're eliminating single-use plastics across our fleet by introducing refillable toiletry dispensers, bamboo room keys, cloth laundry bags, and more. Along the way, we've discovered that these high quality, sustainable alternatives also provide a more luxurious experience than their disposable counterparts.

EXPERIENCES

Our **Make Travel Matter® Experiences** take guests on unique and immersive local experiences that show them how their travels can directly and positively impact the destinations they visit. We already have MTM Experiences on 25% of our itineraries and are striving to reach 100% by 2025.

TRAVEL WITH THE WORLD'S MOST AWARDED

Luxury River Cruise Line

Uniworld proudly holds the proud title of the world's most decorated river cruise line, a status reflected in our impressive collection of accolades and industry recognition. Each year, our commitment to creating exceptional voyages is acknowledged with a host of esteemed awards. These honours aren't just granted by industry professionals and travel agents; they're also a result of the overwhelming appreciation expressed by our treasured guests.

Here is a sample of our prestigious accolades:



INSIGHTS FROM OUR LOYAL GUESTS

Our guest reviews are integral to ensuring we continue to deliver the finest experiences within the industry. You can explore some of our favourites below:

"Six river cruises with Uniworld and we love everything about them, the amazing ships, the delicious dining experiences, and the enlightening shore experiences. Uniworld offers a perfect stress-free experience from initial booking to the actual cruise." - HARRY

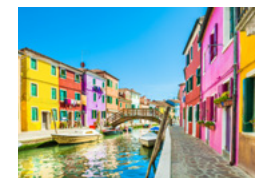

"Very soon after boarding I quickly understood that I was not an anonymous number but was an individual guest with personal preferences that staff were keen to discover and meet. Every day of my cruise experience the staff showed their care and attention to detail, as a newcomer to river cruising, I can only say that my first ever experience on Uniworld's S.S. Bon Voyage, continues to give me fabulous memories on which to look back and treasure." - DEBORAH



"If you like luxury, then Uniworld River Cruises are for you. Their all-inclusive offering is unrivalled to anyone in the industry, from their drinks inclusions to immersive shore excursions. We prefer river cruises to the sea options and although we look at alternative operators, for us, the Uniworld experience is second to none and simply cannot be beaten" - MIKE & HEATHER



"Despite having many great holidays around the world, I have rarely fed back on a holiday experience – however I felt obliged to share our 15-day India's Golden Triangle & the Sacred Ganges cruise was the best holiday we have ever done. After watching this itinerary on cruising India with Jane McDonald, we were reassured that Uniworld would deliver an exceptional experience – which they did! I can't recommend them enough." - DEREK



"After sailing through Venice with Uniworld I was blown away by the whole experience. The ship was beautiful, and the shore excursions were truly unforgettable. I was so impressed with Uniworld I have booked again! As a solo traveller it's a very safe and organised way to travel and meet new friends." - LESLEY

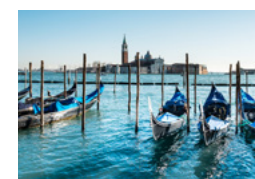

WE'RE THE HIGHEST RATED LUXURY RIVER CRUISE LINE ON FEEFO

We're proud to be the highest rated luxury river cruise line on Feefo, an independent customer review site that verifies every single review we receive. Due to our rating being exceptional over a three-year period, we have once again been crowned a **Platinum trusted service provider** – we are the only luxury river cruise line to achieve this! Our reviews have an average of **4.8/5* from over 14,000 reviews**. This recognition showcases Uniworld's unwavering dedication to providing unparalleled experiences and exceeding the expectations of our valued guests.



INDUSTRY-LEADING LUXURY AMENITIES

Don't settle for anything less

There's all-inclusive, and then there's the unmatched level of inclusive luxurious amenities that only we provide. To ensure truly carefree and effortless travel, we've gone ahead and included it all-so the only thing you have to do is sit back, relax and enjoy the Uniworld difference.



01
FLIGHTS FROM LONDON*



06
SHIPWIDE INTERNET AND WI-FI ACCESS



02
UNLIMITED CHOICE OF PREMIUM SPIRITS AND WINES



07
LOCALLY INSPIRED ONBOARD ENTERTAINMENT



03
REGIONALLY INSPIRED FINE-DINING



08
CHOICE OF CAREFULLY CURATED EXCURSIONS



04
ALL GRATUITIES ONBOARD



09
IN-SUITE BUTLER SERVICE



05
SPECIAL IN-ROOM PAMPERING



10
ALL SCHEDULED AIRPORT TRANSFERS

*NOTE: Amenities may differ in Peru, Egypt, India and Vietnam & Cambodia.
* Regional departures available upon request, supplement may be required.
Please see Terms & Conditions for complete details.*

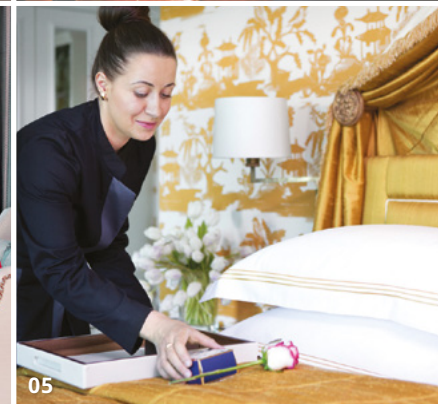



Scan code to watch a video about this cruise

CASTLES ALONG THE RHINE

Super Ship Antoinette, River Queen or Super Ship Victoria (NEW FOR 2024)

Find inspiration in the romantic, soul-stirring beauty of the fabled Rhine. The spires of medieval churches and castles appear around each bend in the river, and vineyards climb the verdant hillsides.

BASEL TO AMSTERDAM | DAYS: 8 | 4 COUNTRIES
INCLUDES FLIGHTS OR EUROSTAR FROM LONDON

feefo Service Rating **★★★★★** Product Rating **★★★★★**
1845 reviews



ONCE-IN-A-LIFETIME EXPERIENCES

- Step into a real-life fairytale as you enter the fortress of Marksburg Castle, the only undamaged hill castle along the Rhine.



- Stroll through the picturesque wine village of Rudesheim and embark on a scenic gondola ride to the top of the Niederwald Monument.
- Enjoy a unique experience as part of our Masterpiece Collection; a gourmet vinegar cooking class.

DAY 1: Basel (Embark)

Welcome to Basel. Upon arrival, you will be greeted by a Uniworld representative to be transferred directly to your Ship to begin your luxury river cruise. (D)

DAY 2: Breisach

Breisach is your gateway to the Alsatian wine road and your launching point for an excursion along the celebrated Route des Vins, which hugs the foothills of the Vosges mountain range. This morning, enjoy leisure time as you sail the scenic Upper Rhine to Breisach. A special Captain's Welcome Reception and Dinner will be prepared for you this evening. (B, L, WD)

Featured Excursions: Alsatian villages.

DAY 3: Kehl (Strasbourg)

See Strasbourg on foot with an insightful local expert, where this historic town with its cobbled lanes, half-timbered homes, giant stork nests and impossible-to-resist pastry shops will win your heart. Kehl, directly across the river from Strasbourg, will be your ship's base while you explore the Alsatian capital. If you're feeling adventurous, take advantage of Uniworld's bicycles or Nordic walking sticks and explore the banks of the river. You have the entire afternoon to see more of Strasbourg on your own. (B, L, D)

Featured Excursions: Strasbourg panoramic tour with cathedral and Old Town walk.

DAY 4: Mannheim (Speyer)

Speyer-spire" in English-is well named, since the four red towers of the Romanesque cathedral dominate the Old Town. (B, L, D)

Featured Excursion: Private Doktorenhof vinegar estate visit and tasting or Formula 1 Racetrack or drive out to the forest for a private tour at a unique old flour mill.

DAY 5: Rudesheim, Boppard

Experience Germany's fabled Rhine River in the towns of Rudesheim and Boppard. Enjoy a private tasting of estate-grown Rieslings at Castle Vollrads, take a stroll through beautiful Boppard, or hike through some of the most beautiful landscapes that line the Rhine. This morning, you'll cruise out of Rudesheim and into the sublimely beautiful and romantic Upper Middle Rhine Valley. (B, L, D)

Featured Excursions: Choice of Castle Vollrads wine tasting or Boppard Village Stroll or "Let's Go" Rhine hiking.

DAY 6: Boppard, Koblenz

Get to know Koblenz, a historic town with a colourful past and eclectic architecture, and enjoy a visit to the stunningly medieval Marksburg Castle. As you come upon picture-perfect Koblenz, you'll sail past Deutsches Eck (German Corner) with its historic monument to Kaiser Wilhelm I. (B, L, D)

Featured Excursions: "Let's Go" Bike the Castles and a choice of Koblenz Walking Tour or Marksburg Castle Visit.

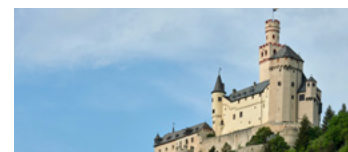

DAY 7: Cologne

History buffs will enjoy an expertly led tour through Cologne's Old Town, where three medieval gates remain standing, as does the old city hall with its Renaissance façade. Wander through the city's historical centre and take in its charming atmosphere, narrow alleyways flanked by old houses and countless breweries. No matter how you choose to explore Old Town, you'll also have ample free time to explore on your own. In the evening, a special Captain's Farewell Reception and Dinner will be prepared for you. (B, L, D)

Featured Excursion: Cologne walking tour.

DAY 8: Amsterdam (Disembark)

Disembark the ship and be transferred to the airport to begin your journey home. (B)

3 DAY LAKE LUCERNE PRE/POST-CRUISE EXTENSION

Your Castles along the Rhine cruise will give you a brief and charming sample of Swiss culture with a stop in Basel-extend your time in Switzerland before or after your cruise with 2 nights in the pretty lake town of Lucerne to immerse yourself in the centre of Swiss life.

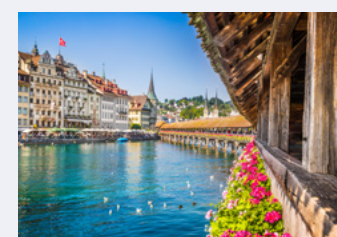

THE FINEST LUXURY AMENITIES

ON-BOARD

- Regionally inspired fine-dining through breakfast, lunch and dinner
- Unlimited premium beverages including fine-wines, locally sourced beers, handmade cocktails and top-shelf spirits
- Locally inspired onboard entertainment
- Unforgettable service from our exceptional team
- Free Wi-Fi Access
- Gratuities for onboard staff

ON LAND

- Your choice of culturally enriching shore excursions - many of which are VIP experiences unique to Uniworld
- Visit to the regions most popular landmarks including UNESCO Heritage Sites
- Airport to ship transfers
- Flights from London (regional available upon request)

THE LUXURY NEW YEAR SALE EVENT

Book by 31st January

2024 Spring/Autumn

Cabin Type	Was From	Now From
Classic	NA	£3,299

2024 Summer

French Balcony	£3,699	£3,199
----------------	--------	--------

2025 dates and pricing now available
See our contact details below for more information

Prices shown are per person guide prices based on lowest lead in rates and must always be checked before booking. Price shown based on two guests sharing a double occupancy cabin, including flights from London. Supplements may apply for regional airports and may vary on certain airlines. Day to day activities, inclusions and itinerary details are subject to change. Prices shown are correct at time of print, may fluctuate up or down throughout the year.

FOR THE LATEST OFFERS AND PRICING, ALWAYS CHECK WITH YOUR TRAVEL AGENT

RIVER HERITAGE CLUB MEMBERS

Past guests of Uniworld will receive an additional £150pp off this itinerary



MAGNIFICENT MOSELLE & RHINE

S.S. Victoria (NEW FOR 2024) or S.S. Elisabeth (NEW FOR 2025)

Germany's spectacular backdrops and breathtaking natural wonders will reveal themselves as you cruise along the alluring Moselle and Rhine rivers. Uncover the best-kept secret in river cruising, the Moselle, as you sail past some of Europe's most serene, village-dotted and vineyard-lined landscapes.

FRANKFURT TO FRANKFURT | DAYS: 10 | 2 COUNTRIES
INCLUDES FLIGHTS FROM LONDON

feefo Service Rating **★★★★★** Product Rating **★★★★★**
29 reviews

ONCE-IN-A-LIFETIME EXPERIENCES

- Pedal through scenic riversides on a Let's Go bike ride in Germany's Middle Moselle.
- Stroll the halls of a medieval castle, perched on a hill above a storybook village.
- Take a cable car up to the Vierseenblick, a vantage spot with a name that translates to "Four Lakes View."



DAY 1: Frankfurt (Embark)

Welcome to Frankfurt. Upon arrival, you will be greeted by a Uniworld representative to be transferred directly to your Ship to begin your luxury river cruise. (D)

DAY 2: Cochem

Spend the day taking in pretty Moselle riversides, arriving in Cochem in the evening. The picturesque town of Cochem is nestled in a particularly scenic area of the Moselle Valley. The Moselle River cuts through the town, leaving Cochem in two distinct halves on two steep hills. (B, L, WD)

DAY 3: Cochem

Perhaps one of Germany's most colourful cities, Cochem feels just like a storybook with its dramatic castle, impressive landscapes and pastel-coloured shops, restaurants and buildings lining the banks of the Moselle. Perched high above on a cliff sits the brilliant Cochem Castle, or Reichsburg Cochem, which brings German history and culture to life and provides panoramic views of the Moselle and Cochem below, which you'll have the chance to see today on a walking tour of the city. (B, L, D)

Your Call: Cochem Walking Tour with Reichsburg Castle or "Let's Go" hiking the suspension bridge of Geierlay.

DAY 4: Trier

Trier is no stranger to famous landmarks, stunning cathedrals, natural beauty, UNESCO World Heritage Sites and architectural treasures. See Trier's Roman heritage and Gallic charm as you stroll to some of the city's most notable spots. Marvel at the stone Roman gate, Porta Nigra, the Karl Marx house, Imperial Baths and more. Alternatively, you can choose to visit the small neighbouring country of Luxembourg. Experience a healthy dose of history with a visit to the expansive Luxembourg American War Cemetery and Memorial, where General George S. Patton is buried. (B, L, D)

Featured Excursions: Trier panoramic city tour or Luxembourg with WWII Cemetery visit.

DAY 5: Bernkastel

Bernkastel sits peacefully in the Moselle Valley and is as romantic and picture-perfect as it gets. Explore by foot its scenic streets, taverns and vineyards, and enjoy a tasting of exceptional regional Rieslings. Aside from the medieval marketplace, a must-see is the Graach Gate, the last remaining town gate of Bernkastel-Kues. Its original purpose was that of protection, helping to ward off foreign aggression in the 1300s, but

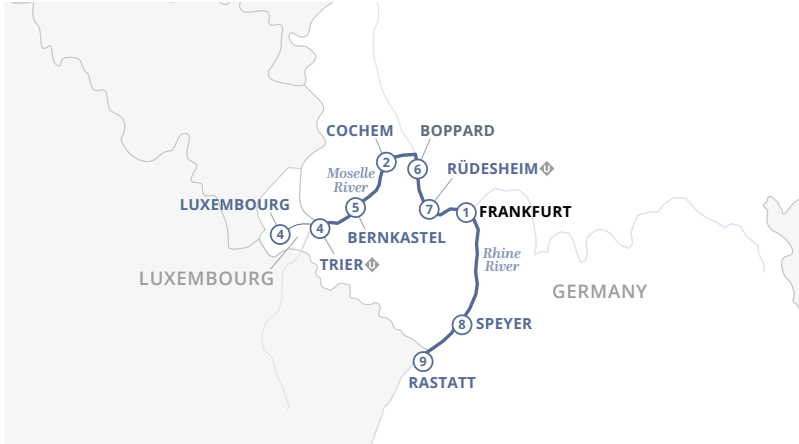

now it's a museum of local history and a beloved landmark. If a bike is your transportation of choice, cycle along the dreamy paths of the Middle Moselle. (B, L, D)

Featured Excursions: "Let's Go" biking the scenic Middle Moselle or Bernkastel village walk with Riesling tasting.

DAY 6: Boppard

Wander through Boppard's stone-paved streets, riverside walking paths and historic centre, stopping in for wine at the half-timbered taverns serving up exceptional Riesling from grapes grown on nearby vineyards. (B, L, D)

Featured Excursion: Boppard village stroll.

DAY 7: Rüdesheim

In Rüdesheim, make your way up to arguably the best view in the entire region, Rhine Bend, by scenic chairlift ride. See the Rhine River at its most astonishing point and stroll through its vineyard-dotted hillsides before heading back down to its waterfront streets to enjoy a walk around town, complete with local treats. (B, L, FD)

Included Night Out Excursion: Abbey Eberbach Wine Tasting

Featured Excursions: Rüdesheim walk with local treats or Rheinweinwelten visit - The best Rhine Rieslings.

DAY 8: Speyer

For something really unexpected, venture into a mysterious, candlelit tasting room to sample flavourful elixirs made from wine vinegars. Utterly unique and surprisingly delicious. Or you can embark on a walking tour of the city, and enjoy some delicious snacks along the way. (B, L, D)

Featured Excursions: Speyer Walking Tour with Local Treats or Private Doktorenhof Vinegar Estate visit and tasting.

DAY 9: Rastatt, Baden-Baden

Rastatt is our launch point today for a day trip to the luxe spa town of Baden-Baden. Delight in its cosmopolitan flair with a city tour culminating in a visit to the famous Casino Baden-Baden. In the evening, a special Captain's Farewell Reception and Dinner will be prepared for you. (B, L, FD)

Featured Excursion: Baden-Baden city tour with casino.

DAY 10: Frankfurt (Disembark)

Disembark the ship and be transferred to the airport to begin your journey home. (B)

THE FINEST LUXURY AMENITIES

ON-BOARD

- Regionally inspired fine-dining through breakfast, lunch and dinner
- Unlimited premium beverages including fine-wines, locally sourced beers, handmade cocktails and top-shelf spirits
- Locally inspired onboard entertainment
- Unforgettable service from our exceptional team
- Free Wi-Fi Access
- Gratuities for onboard staff

ON LAND

- Your choice of culturally enriching shore excursions - many of which are VIP experiences unique to Uniworld
- Visit to the regions most popular landmarks including UNESCO Heritage Sites
- Airport to ship transfers
- Flights from London (regional available upon request)

— THE LUXURY — NEW YEAR SALE EVENT

Book by 31st January

2024 Summer

Cabin Type	Was From	Now From
Classic	£4,899	£4,399

2025 dates and pricing now available
See our contact details below for more information

Prices shown are guide prices based on lowest lead rates and must always be checked before booking. Price shown based on two guests sharing a double occupancy cabin, including flights from London. Supplements may apply for regional airports and may vary on certain airlines. Day to day activities, inclusions and itinerary details are subject to change. Prices shown are correct at time of print, may fluctuate up or down throughout the year.

FOR THE LATEST OFFERS AND PRICING, ALWAYS CHECK WITH YOUR TRAVEL AGENT

RIVER HERITAGE CLUB MEMBERS

Past guests of Uniworld will receive an additional £250pp off this itinerary

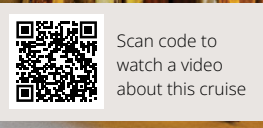

VENICE & THE JEWELS OF VENETO

Super Ship La Venezia - Maximum Guests: 126

Uncover the enchanted beauty and breathtaking history of the Veneto region - including visits to surrounding islands. Our boutique floating hotel gives exclusive access unavailable anywhere else. With everything you could ever need included, there's truly no better way to explore Venice in unrivalled luxury.

VENICE TO VENICE | DAYS: 8 | 1 COUNTRY
INCLUDES FLIGHTS FROM LONDON

feefo Service Rating **★★★★★** Product Rating **★★★★★**
106 reviews



ONCE-IN-A-LIFETIME EXPERIENCES

- Enjoy an exclusive after hours lighting ceremony in St. Marks Basilica - only available to Uniworld guests.

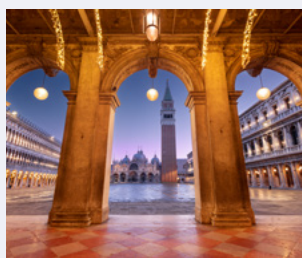

- Enjoy bonus time on the island of Burano as Uniworld are the only ship permitted to dock here.
- Experience the magic of Doge's Palace with exclusive early morning access, without the crowds and only available to Uniworld guests.
- Sail into the heart of the Venetian lagoon for an entirely unique view of this remarkable city.

DAY 1: Venice (Embark)

Welcome to Venice. Upon arrival, you will be greeted by a Uniworld representative to be transferred directly to board the *Super Ship La Venezia* to begin your luxury river cruise. (D)

DAY 2: Venice

With your early morning arrival at Doge's Palace, you'll be able to marvel at the estate in total peace. Wander through a Venetian neighbourhood and experience daily life in an authentic Venetian residential quarter. Later in the evening, cap the day off with a private once-in-a-lifetime experience at an after-hours lighting ceremony inside St. Mark's Basilica without the crowds. (B, L, D)

Featured Excursions: *A morning walk in Venice with Doge's Palace visit and private after-hours visit to St. Mark's Basilica - a once-in-a-lifetime experience only available to Uniworld guests.*

Included Night Out Excursion: *Tonight the doors of St Marks Basilica open exclusively for Uniworld guests to enjoy.*

DAY 3: Venice, Mazzorbo (Burano)

Start your morning in one of two of the Veneto region's UNESCO World Heritage cities, Vicenza or Padua. In the afternoon, you'll have the opportunity to join us on a walk in Venice to meet a local gondola artisan before reboarding the ship for scenic sailing across the lagoon as we head towards Mazzorbo and Burano. A special Captain's Welcome Reception and Dinner will be prepared for you this evening. (B, L, WD)

Featured Excursion: *Evening stroll in Burano or Vicenza with Teatro Olimpico or Padua Walking Tour*

DAY 4: Mazzorbo, Burano, Chioggia

Spend the day exploring the northern lagoon of Venice and its captivating islands. Start with a visit to Torcello's famous basilica with an art historian, then stroll through the agricultural island of Mazzorbo and the rainbow-hued island of Burano during your free time after lunch. Alternatively, you can take the afternoon to see the renowned glassblowing artisans of Murano at work. (B, L, D)

Featured Excursions: *Torcello: Hidden Treasure of the Lagoon and Murano Glass Blowing Demonstration.*

DAY 5: Chioggia

Today, you'll admire the greatest sites of charming and coastal Chioggia, including a stop at the local and lively market. (B, L, D)

Your Call: *Choice of Chioggia Market Visit or "Let's Go" Biking Chioggia or Bragozzo Ride with Tastings at Ca' Zen or Noble Country Villas and Their Wines.*

DAY 6: Chioggia, Venice

This morning, join a sailing excursion where you'll explore the Po Delta where the Po River and the Adriatic Sea meet. Later, during lunch, we sail back to Venice. (B, L, D)

Featured Excursion: *Po Delta Sailing or Castello del Catajo Visit.*

DAY 7: Venice

As your water taxi glides past narrow side canals and the Canal Grande, you'll arrive in style at the Rialto Bridge. The iconic stone arch bridge sits at the narrowest point of the Canal Grande and holds numerous shops and restaurants. A special Captain's Farewell Reception and Dinner will be prepared for you this evening. (B, L, FD)

Featured Excursions: *Venice Walk with Gondola Artisans Visit or do as the Locals Do: Venice Walking Tour or Ca' Macana Mask Atelier or Rowing Venice experience.*

DAY 8: Venice (San Basilio) (Disembark)

Disembark the ship and be transferred to the airport to begin your journey home. (B)

3 DAY EXTENSION TO MILAN WITH VERONA VISIT

For the ultimate Italian adventure, our full package with Milan is truly spectacular. With exclusive money-can't-buy tickets to view the *Last Supper* and a lunch at a breathtaking winery, it's the ideal way to prepare for your Venetian adventure.



Exclusive private access to Leonardo da Vinci's *The Last Supper*

THE FINEST LUXURY AMENITIES

ON-BOARD

- Regionally inspired fine-dining through breakfast, lunch and dinner
- Unlimited premium beverages including fine-wines, locally sourced beers, handmade cocktails and top-shelf spirits
- Locally inspired onboard entertainment
- Unforgettable service from our exceptional team
- Free Wi-Fi Access
- Gratuities for onboard staff

ON LAND

- Your choice of culturally enriching shore excursions - many of which are VIP experiences unique to Uniworld
- Visit to the regions most popular landmarks including UNESCO Heritage Sites
- Airport to ship transfers
- Flights from London (regional available upon request)

— THE LUXURY — NEW YEAR SALE EVENT

Book by 31st January

2024 Spring/Autumn

Cabin Type	Was From	Now From
Classic	-	£2,549

2024 Summer

Classic	£3,599	£3,099
---------	--------	--------

2025 dates and pricing now available
See our contact details below for more information

Prices shown are per person guide prices based on lowest lead in rates and must always be checked before booking. Price shown based on two guests sharing a double occupancy cabin, including flights from London. Supplements may apply for regional airports and may vary on certain airlines. Day to day activities, inclusions and itinerary details are subject to change. Prices shown are correct at time of print, may fluctuate up or down throughout the year.

FOR THE LATEST OFFERS AND PRICING, ALWAYS CHECK WITH YOUR TRAVEL AGENT

RIVER HERITAGE CLUB MEMBERS

Past guests of Uniworld will receive an additional £100pp off this itinerary



Scan code to watch a video about this ship

DOURO RIVER VALLEY

Super Ship São Gabriel - Maximum Guests: 100

As you follow the Douro River through Portugal and into Spain, you'll cruise past steeply terraced hillsides, quaint villages and acres of ripe vineyards. There's no better way to discover Europe's best-kept secret than this scenic and all-inclusive river cruise!

PORTO TO PORTO | DAYS: 8 | 2 COUNTRIES
INCLUDES FLIGHTS FROM LONDON

feefo Service Rating **★★★★★** Product Rating **★★★★★**
115 reviews

ONCE-IN-A-LIFETIME EXPERIENCES

- Head ashore for a choice of daily excursions, including multiple tastings of port at award-winning, prestigious estates.



- Take in the scenic delights as you sail from Vila Nova da Gaia to the mouth of the Douro River and back.
- Dine at a family-run restaurant for a typical Portuguese lunch, which includes Portugal's iconic caldo verde.
- Cruise through the UNESCO Listed Douro River Valley, a region described by many as the best kept secret in river cruising.

DAY 1: Porto (Embark)

Welcome to Porto. Upon arrival, you will be greeted by a Uniworld representative to be transferred directly to board the *Super Ship São Gabriel* to begin your luxury river cruise. (D)

DAY 2: Porto, Entre-os-Rios

Portugal's second city (after Lisbon), Porto gave its name to the nation's most famous export, Port wine, and to the nation itself. Today, choose between two distinctively Portuguese ways to explore Porto. (B, L, WD)

Featured Excursions: Choice of Porto city tour or "Do as the Locals Do" Porto walking tour.

DAY 3: Entre-os-Rios, Régua

Today is all about wine, which has been cultivated in the Douro River Valley since ancient Roman times. Get a crash course on the history of Port during your visit to the Douro Museum. (B, L, D)

Featured Excursions: Douro Museum or Lamego Heritage Tour.

Included Night Out Excursion:

Quinta Dinner - Travel up winding roads with spectacular views and breath-stealing drop-offs for a traditional dinner bursting with regional flavours.

DAY 4: Régua, Pocinho, Vega de Terrón

Go medieval today at Castelo Rodrigo, both the name of a hilltop castle as well as the village that surrounds it. The view from the top is incredible and the village is a charming place to ramble, relax and replenish. Alternatively, lace up your hiking boots and unleash your inner Indiana Jones with an up-close gander at some prehistoric carvings at an archaeological park. (B, L, D)

Featured Excursion: Choice of Archaeological Park of the Côa Valley or Castelo Rodrigo.



DAY 5: Vega de Terrón (Salamanca), Barca d'Alva

Today, you can visit the historic university town of Salamanca-the "Golden City"-famous for its sand-coloured buildings and abundance of churches. Feel the centuries fall away as your ship winds its way through the pristine, dramatic UNESCO-protected landscapes of the Douro River Valley. (B, D)

Featured Excursion: Salamanca, the Golden City, and Spain's oldest university.

DAY 6: Barca d'Alva, Régua

Head ashore for a choice of excursions, including a tasting at a prestigious Port wine estate or a vineyard hike with a wine tasting at a local quinta. (B, L, D)

Featured Excursions: Local Quinta Guided Tour with Tasting or Vineyard Hike and Wine Tasting at a Local Quinta.

DAY 7: Régua (Guimarães), Porto

Explore Guimarães, the town where Portugal was born. Its well-preserved architecture and stylish young residents make it a pleasure to visit. In the evening, a special Captain's Farewell Reception and Dinner will be prepared for you. (B, L, FD)

Featured Excursion: Choice of Guimarães city tour.

DAY 8: Porto (Disembark)

Disembark the ship and be transferred to the airport to begin your journey home. (B)

3 DAY EXTENSION TO LISBON

Explore Lisbon's blend of old-world charm and modern allure with our post-cruise extension, featuring a three-night stay at the prestigious five-star *Tivoli Avenida Liberdade*. As the 2019 World's Leading City Break Destination, Lisbon offers an ideal visit for travellers seeking a unique cultural experience.



THE FINEST LUXURY AMENITIES

ON-BOARD

- Regionally inspired fine-dining through breakfast, lunch and dinner
- Unlimited premium beverages including fine-wines, locally sourced beers, handmade cocktails and top-shelf spirits
- Locally inspired onboard entertainment
- Unforgettable service from our exceptional team
- Free Wi-Fi Access
- Gratuities for onboard staff

ON LAND

- Your choice of culturally enriching shore excursions - many of which are VIP experiences unique to Uniworld
- Visit to the regions most popular landmarks including UNESCO Heritage Sites
- Airport to ship transfers
- Flights from London (regional available upon request)

— THE LUXURY — NEW YEAR SALE EVENT

Book by 31st January

2024 Spring/Autumn

Cabin Type	Was From	Now From
Classic	-	£3,499

2024 Summer

Classic	£4,799	£4,299
---------	--------	--------

2025 dates and pricing now available
See our contact details below for more information

Prices shown are per person guide prices based on lowest lead in rates and must always be checked before booking. Price shown based on two guests sharing a double occupancy cabin, including flights from London. Supplements may apply for regional airports and may vary on certain airlines. Day to day activities, inclusions and itinerary details are subject to change. Prices shown are correct at time of print, may fluctuate up or down throughout the year.

FOR THE LATEST OFFERS AND PRICING, ALWAYS CHECK WITH YOUR TRAVEL AGENT

RIVER HERITAGE CLUB MEMBERS

Past guests of Uniworld will receive an additional £100pp off this itinerary



BRILLIANT BORDEAUX

Super Ship Bon Voyage - Maximum Guests: 124

Uncover the proud legacy and heritage of Southwest France as you set sail along three stunning rivers; the Garonne, Dordogne and Gironde. Wander through archaeological marvels, historic landmarks and magnificent vineyards where you'll be treated to a sampling of quintessentially French experiences.

BORDEAUX TO BORDEAUX | DAYS: 8 | 1 COUNTRY
INCLUDES FLIGHTS OR EUROSTAR FROM LONDON

feefo Service Rating Product Rating
419 reviews ★★★★★ ★★★★★

ONCE-IN-A-LIFETIME EXPERIENCES

- Wander through archaeological marvels, historic landmarks and magnificent vineyards where you'll be treated to a sampling of quintessentially French experiences.



- Experience multiple private wine tastings, village tours and farmers' market visits on a showcase of the very best Southwest France has to offer.
- Journey through the vineyards to Château Royal de Cazeneuve for a private tour and Sauternes tasting.
- Experience the Bassins des Lumières, a stunning and immersive light show projected against the walls of the base.

DAY 1: Bordeaux (Embark)

Welcome to Bordeaux. Upon arrival, you will be greeted by a Uniworld representative to be transferred directly to board the *Super Ship Bon Voyage* to begin your luxury river cruise. (D)

DAY 2: Cadillac

The French phrase "la douceur de vivre" is an accurate description for your time in Cadillac, known for its deliciously flavoured dessert wines. Visit Château Royal de Cazeneuve, site of Henry IV's and Queen Margot's tempestuous love. Meet the owner around a glass of Sauternes in the reception hall. In the evening, a special Captain's Welcome Reception and Dinner will be prepared for you. (B, L, WD)

Featured Excursions: *Choice of Private owner's tour of Royal Château with Sauternes toast or The colourful life of Toulouse Lautrec at Château de Malromé.*

DAY 3: Cussac Fort Médoc

The legendary Médoc region abounds with prestigious wine châteaux in a dizzying array of architectural styles, as well as miles of grapevines stretching to infinity. Take a scenic drive through the storied Médoc wine route, followed by a wine tasting at a beautiful wine estate. (B, L, D)

Featured Excursions: *Fresh Médoc oysters tasting or choice of Let's Go: Bike in the Médoc Vineyards or Médoc Châteaux route with private wine tasting.*

DAY 4: Blaye, Bourg sur Gironde

The Route de la Corniche Fleurie...could this be the most beautiful road you've ever travelled? Find out today on the drive to Blaye Fortress, passing through one impossibly picturesque hamlet after another. Once you arrive, you'll discover the wonders of this historic fortress, a UNESCO-designated citadel that once protected Bordeaux from attacks by sea. (B, L, D)

Featured Excursion: *Panoramas of Route de la Corniche Fleurie with Blaye Fortress.*

DAY 5: Libourne (Saint-Émilion)

With Libourne as your base, travel to nearby breathtaking Saint-Émilion and immerse yourself more deeply in the region's history and wine culture. The medieval town of Saint-Émilion is an ideal place to linger. Wander its cobblestone lanes lined with wine shops and bakeries, and stop to admire the amazing rock-hewn church that extends beneath the city's streets. (B, D)

Featured Excursion: *Saint-Émilion walking tour with wine tasting.*

DAY 6: Libourne, Bordeaux

France's rich agricultural tradition is the heart and soul of the region's exquisite cuisine-and what better way to get a taste for the freshest vegetables, cheeses, breads and fruits than with a visit to Libourne's lively farmers' market? In the evening, a special Captain's Farewell Reception and Dinner will be prepared for you. (B, L, FD)

Featured Excursion: *Libourne "Village Day" with farmers' market.*

Included Night Out Excursion: *Tonight you'll visit Bassins des Lumières, a stunning light show projected against the walls of a WWII submarine base.*

DAY 7: Bordeaux

Discover Bordeaux's many charms today, either on foot with a local expert or on two wheels-the locals' preferred way to navigate the city's charming backstreets. You have a wonderful selection of active opportunities to see this magnificent UNESCO World Heritage Site. (B, L, D)

Featured Excursions: *"Let's Go" bike Bordeaux backstreets or "Do as the Locals Do" Bordeaux walking tour.*

DAY 8: Bordeaux (Disembark)

Disembark the ship and be transferred to the airport to begin your journey home. (B)

THE ULTIMATE FRENCH ADVENTURE

For an extra-special experience in France, **why not combine all our itineraries into one across 22 unforgettable days.** Explore the best of France has to offer and stay on three stunning Super Ships. Contact us below for latest pricing and more information.



THE FINEST LUXURY AMENITIES

ON-BOARD

- Regionally inspired fine-dining through breakfast, lunch and dinner
- Unlimited premium beverages including fine-wines, locally sourced beers, handmade cocktails and top-shelf spirits
- Locally inspired onboard entertainment
- Unforgettable service from our exceptional team
- Free Wi-Fi Access
- Gratuities for onboard staff

ON LAND

- Your choice of culturally enriching shore excursions - many of which are VIP experiences unique to Uniworld
- Visit to the regions most popular landmarks including UNESCO Heritage Sites
- Airport to ship transfers
- Flights from London (regional available upon request)

— THE LUXURY — NEW YEAR SALE EVENT

Book by 31st January

2024 Spring/Autumn

Cabin Type	Was From	Now From
Classic	£2,999	£2,499

2024 Summer

Classic	£3,299	£2,799
---------	--------	--------

2025 dates and pricing now available

See our contact details below for more information

Prices shown are per person guide prices based on lowest lead in rates and must always be checked before booking. Price shown based on two guests sharing a double occupancy cabin, including flights from London. Supplements may apply for regional airports and may vary on certain airlines. Day to day activities, inclusions and itinerary details are subject to change. Prices shown are correct at time of print, may fluctuate up or down throughout the year.

FOR THE LATEST OFFERS AND PRICING, ALWAYS CHECK WITH YOUR TRAVEL AGENT

RIVER HERITAGE CLUB MEMBERS

Past guests of Uniworld will receive an additional £150pp off this itinerary



BURGUNDY & PROVENCE

Super Ship Catherine - Maximum Guests: 150

A journey of exquisite pleasures cruising along the Rhône and Saône rivers, where you will sample regional delights along the way. Highlights include strolling Arles, the streets made famous by Van Gogh and visiting Avignon's majestic Palace of the Popes.

ARLES TO LYON | DAYS: 8 | 1 COUNTRY
INCLUDES FLIGHTS OR EUROSTAR FROM LONDON

feefo Service Rating **★★★★★** Product Rating **★★★★★**
930 reviews

ONCE-IN-A-LIFETIME EXPERIENCES

- Follow in the footsteps of Van Gogh, Cézanne and Gauguin on this exquisite journey through southern France.



- Visit the UNESCO World Heritage listed Pont du Gard as well as enjoying a private tour in the nearby museum.

DAY 1: Arles (Embark)

Welcome to Arles. Upon arrival, you will be greeted by a Uniworld representative to be transferred directly to board the *Super Ship Catherine* to begin your luxury river cruise. (D)

DAY 2: Arles

Explore a sun-drenched Provençal town today with an allure all its own. Known for its remarkable Roman ruins, Arles so inspired Van Gogh that he painted some 200 paintings there. Arles has existed since the sixth century BC, when the ancient Greeks founded it and named it Theline. It was here that the Romans built their first bridge across the Rhône River, creating a vital overland route between Italy and Spain. (B, L, D)

Featured Excursions: *Arles walking tour.*

DAY 3: Avignon

The walled city of Avignon is one of the most fascinating towns in southern France, with a host of historic gems to explore-including the fortress residence of rebellious popes who broke from Rome and once lived and ruled here. You'll see the Palace of the Popes and much more today, and also have a chance to kayak under a 2,000-year-old Roman aqueduct. A special Captain's Welcome Reception and Dinner will be prepared for you this evening. (B, L, WD)

Featured Excursions: *Choice of Avignon walking tour with Palace of the Popes or Pont du Gard Roman Aqueduct visit.*

DAY 4: Viviers

An enchanting village where time seems to have stopped centuries ago, Viviers has a long and storied past that goes back more than 1,600 years-and a splendid architectural heritage to match. At one time, Viviers was divided along religious lines-the clergy lived in the upper part of the town, the laity in the lower part. Your exploration of the town will take you through both parts, as you begin at the crest and make your way to the riverbank. (B, L, D)

Featured Excursion: *Intimate Viviers "Village Day."*

DAY 5: Tournon (Tain-l'Hermitage)

If you love fine wine, you'll love the twin villages of Tournon and Tain-l'Hermitage. Tournon may be a small town, but stirring events took place here: A castle was raised on the hilltop in the 10th century to protect the region, and new fortifications were added over the centuries, including two "new" towers built to defend against Protestant attacks in the 16th century. You'll see the handsome houses constructed by wealthy merchants and garrison officers when you walk through



the Rue de Doux area, and you'll pass the 14th-century church and the oldest secondary school in France. (B, L, D)

Featured Excursions: *Choice of Tournon and Tain-l'Hermitage twin villages stroll with wine tasting or "Let's Go" Hermitage terrace vineyards hike with wine tasting.*

DAY 6: Lyon

As the epicentre of French gastronomy, Lyon is a city of tantalising contrasts. From the work of culinary visionaries to silk weavers' secret passageways. After your choice of excursions, embrace the locals' favourite mode of transportation with a bike ride-a great way to see the sights. A special Captain's Farewell Reception and Dinner will be prepared for you this evening. (B, L, FD)

Featured Excursions: *Choice of Lyon Panoramic Tour with Traboules Visit or "Let's Go" Lyon peninsula bike tour or Silk weavers walking tour.*

DAY 7: Mâcon (Beaune)

The pace of life is decidedly more relaxed in Burgundy, where endless rows of grapes hang heavy on the vine. The capital of the region's wine trade, Beaune is renowned for its history, beauty and highly prized wine, as well as its medieval-era hospital-the Hospices de Beaune. (B, L, D)

Featured Excursion: *Burgundy Landscapes, Beaune and the Hospices.*

DAY 8: Lyon (Disembark)

Disembark the ship and be transferred to the airport to begin your journey home. (B)

THE ULTIMATE FRENCH ADVENTURE

For an extra-special experience in France, **why not combine all our itineraries into one across 22 unforgettable days.** Explore the best of France has to offer and stay on three stunning Super Ships. Contact us below for latest pricing and more information.



THE FINEST LUXURY AMENITIES

ON-BOARD

- Regionally inspired fine-dining through breakfast, lunch and dinner
- Unlimited premium beverages including fine-wines, locally sourced beers, handmade cocktails and top-shelf spirits
- Locally inspired onboard entertainment
- Unforgettable service from our exceptional team
- Free Wi-Fi Access
- Gratuities for onboard staff

ON LAND

- Your choice of culturally enriching shore excursions - many of which are VIP experiences unique to Uniworld
- Visit to the regions most popular landmarks including UNESCO Heritage Sites
- Airport to ship transfers
- Flights from London (regional available upon request)

— THE LUXURY —
NEW YEAR SALE EVENT

Book by 31st January

2024 Spring/Autumn

Cabin Type	Was From	Now From
Classic	£3,199	£2,699

2024 Summer

Classic	£4,499	£3,999
---------	--------	--------

2025 dates and pricing now available
See our contact details below for more information

Prices shown are per person guide prices based on lowest lead in rates and must always be checked before booking. Price shown based on two guests sharing a double occupancy cabin, including flights from London. Supplements may apply for regional airports and may vary on certain airlines. Day to day activities, inclusions and itinerary details are subject to change. Prices shown are correct at time of print, may fluctuate up or down throughout the year.

FOR THE LATEST OFFERS AND PRICING, ALWAYS CHECK WITH YOUR TRAVEL AGENT

RIVER HERITAGE CLUB MEMBERS

Past guests of Uniworld will receive an additional £100pp off this itinerary



Scan code to watch a video about this cruise

PARIS & NORMANDY

Super Ship *Joie de Vivre* - Maximum Guests: 128

Cruise from Paris through Normandy's countryside, uncovering its many charms: Richard the Lionheart's Chateau Gaillard, the medieval capital of Rouen, Monet's beloved home in Giverny and the famed Normandy beaches.

PARIS TO PARIS | DAYS: 8 | 1 COUNTRY
INCLUDES FLIGHTS OR EUROSTAR FROM LONDON



Service Rating
★★★★★

Product Rating
★★★★★

ONCE-IN-A-LIFETIME EXPERIENCES

- Walk through the gardens that inspired so many of Monet's paintings at his home in Giverny.



- Tee off at one of France's most outstanding courses, Golf d'Étretat, on a Let's Go experience.
- Revel in a Masterpiece Collection evening at the sensational Moulin Rouge.
- Behold a wreath-laying ceremony at a choice of Normandy beach sites.
- Go behind the scenes at Versailles as you tour the palace and the royal apartments.

DAY 1: Paris (Embark)

Welcome to Paris. Upon arrival, you will be greeted by a Uniworld representative to be transferred directly to board the *Super Ship Joie de Vivre* to begin your luxury river cruise. (D)

DAY 2: La Roche-Guyon, Vernon, Giverny

Today is a celebration of northern France's natural beauty, with an excursion to a splendid chateau and gardens situated in an equally grand setting, plus a chance to immerse yourself in the very landscapes that inspired Impressionist master Claude Monet. In the morning, choose between a scenic hike or a visit the hilltop Château de La Roche-Guyon, surrounded by beautiful gardens and offering sweeping views over the Seine. Later, you can visit the home and gardens of Claude Monet. Or take in the beautiful French countryside in a more invigorating way, with a guided bike ride from Vernon to Giverny. (B, L, WD)

Featured Excursions: Choice of *Château La-Roche Guyon* or "Let's Go" hike on the crests trail, and choice of *Monet's Gardens** at Giverny or "Let's Go" bike ride from Vernon to Giverny.

DAY 3: Rouen

Walk in the footsteps of greatness in Normandy's medieval capital, a city with a historic quarter that remains amazingly intact. From the cathedral Monet painted dozens of times to the cross marking the spot where Joan of Arc was martyred, Rouen is a treasure trove for the culturally curious. The roll call of famous people who lived or died in Rouen is long and varied-Richard the Lionheart, Joan of Arc, Gustave Flaubert and Claude Monet are among them. (B, L, D)

Featured Excursions: Choice of *Rouen Walking Tour*, the *Dukes of Normandy's Capital* or *Camembert Cheese Farm*.

Included Night Out Excursion: Tonight, walk through the streets of Rouen towards the famous cathedral and enjoy a private musical performance.

DAY 4: Caudebec-en-Caux (Honfleur or Étretat)

Caudebec-en-Caux, a lovely little town on the right bank of the Seine Estuary, is your base for one of two very different excursions. You could drive through the beautiful Calvados countryside to Honfleur, a delightful seaside harbour and city of painters, or head to the windy cliffs of Étretat for a game of golf. (B, L, D)

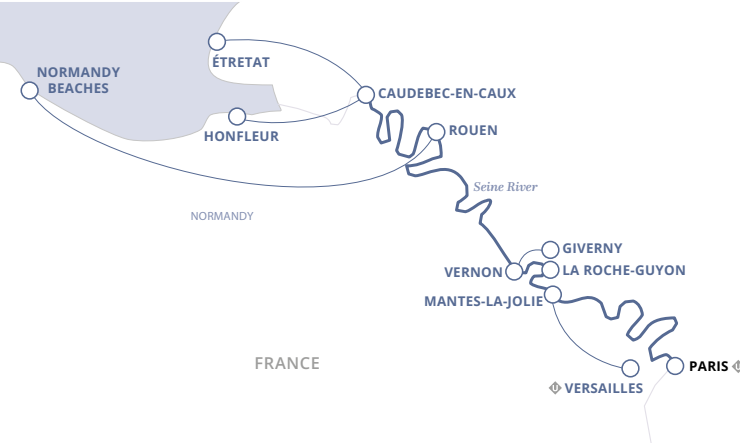

Featured Excursions: Choice of *Honfleur walking tour* or "Let's Go" *Golfing in Étretat*.

DAY 5: Rouen (Normandy Beaches)

On your full-day outing, you'll visit Normandy's beaches, including Utah Beach and Ste-Mère-Église, with a choice to venture to either the American, British and Australian or Canadian beaches. After, you'll go to the American cemetery and partake in a private ceremony at the Omaha Beach Memorial-a sentimental remembrance of Operation Overlord. (B, D)

Featured Excursions: Choice of *Normandy Beaches: Choose from British & Commonwealth, American or Canadian sites*.

DAY 6: Mantes-la-Jolie (Versailles)

How did France's rulers live over the centuries? Step into the private rooms of the Palace of Versailles, the lavish palace built by the Sun King, to find out. A special Captain's Farewell Reception and Dinner will be prepared for you this evening. (B, L, FD)

Featured Excursion: *Versailles Palace secret apartments*.

DAY 7: Paris

Whether you're a first-time visitor to the "City of Light" or you've been here many times before, there's something for everyone today in Paris. Enjoy a panoramic overview of the city, join a local expert for a walk through two much-loved neighbourhoods, or pedal your way along the Left Bank, a fresh and fun way to take in the sights. (B, L, D)

Featured Excursion: Choice of *Paris city tour* or *Paris Walking Tour of the Latin Quarter* or "Let's Go" *Seine riverbanks bike ride*.

DAY 8: Paris (Disembark)

Disembark the ship and be transferred to the airport to begin your journey home. (B)

THE ULTIMATE FRENCH ADVENTURE

For an extra-special experience in France, **why not combine all our itineraries into one across 22 unforgettable days.** Explore the best of France has to offer and stay on three stunning Super Ships. Contact us below for latest pricing and more information.

THE FINEST LUXURY AMENITIES

ON-BOARD

- Regionally inspired fine-dining through breakfast, lunch and dinner
- Unlimited premium beverages including fine-wines, locally sourced beers, handmade cocktails and top-shelf spirits
- Locally inspired onboard entertainment
- Unforgettable service from our exceptional team
- Free Wi-Fi Access
- Gratuities for onboard staff

ON LAND

- Your choice of culturally enriching shore excursions - many of which are VIP experiences unique to Uniworld
- Visit to the regions most popular landmarks including UNESCO Heritage Sites
- Airport to ship transfers
- Flights from London (regional available upon request)

— THE LUXURY —
NEW YEAR SALE EVENT

Book by 31st January

2024 Spring/Autumn

Cabin Type	Was From	Now From
Classic	£3,299	£2,799

2024 Summer

Classic	£4,399	£3,899
---------	--------	--------

2025 dates and pricing now available
See our contact details below for more information

Prices shown are per person guide prices based on lowest lead in rates and must always be checked before booking. Price shown based on two guests sharing a double occupancy cabin, including flights from London. Supplements may apply for regional airports and may vary on certain airlines. Day to day activities, inclusions and itinerary details are subject to change. Prices shown are correct at time of print, may fluctuate up or down throughout the year.

FOR THE LATEST OFFERS AND PRICING, ALWAYS CHECK WITH YOUR TRAVEL AGENT

RIVER HERITAGE CLUB MEMBERS

Past guests of Uniworld will receive an additional £100pp off this itinerary



Scan code to watch a video about this cruise

ENCHANTING DANUBE

Super Ship Maria Theresa - Maximum Guests: 150

A veritable showcase of the best of Central Europe, this new journey is one any culturally curious world traveller will love, featuring old-world capitals and charming towns and villages.

BUDAPEST TO PASSAU | DAYS: 8 | 4 COUNTRIES
INCLUDES FLIGHTS FROM LONDON

feefo
773 reviews

Service Rating
★★★★★

Product Rating
★★★★★

ONCE-IN-A-LIFETIME EXPERIENCES

- In Vienna, the home of classical music you'll get to enjoy a private Mozart & Strauss concert, only available to Uniworld guests.



- Delight in a Morning with the Masters at Vienna's world-class Art History Museum for a tour led by an art historian.
- Savour a Bavarian country cooking class as part of an optional Masterpiece Collection excursion.
- Discover the spice as pure as gold at a saffron workshop.

DAY 1: Budapest (Embark)

Welcome to Budapest. Upon arrival, you will be greeted by a Uniworld representative to be transferred directly to board the *Super Ship Maria Theresa* to begin your luxury river cruise. (D)

DAY 2: Budapest

Budapest is an enchanting city that presents a vibrant mix of medieval and modern. Discover the "Pearl of the Danube" with a choice of incredible excursions. Or enjoy some free time visiting highlights such as Fisherman's Bastion or the remarkable Hungarian Parliament Building. In the evening, a special Captain's Welcome Reception and Dinner will be prepared for you. (B, L, WD)

Featured Excursions: *Budapest Panoramic Highlights with Franz Liszt Academy Visit or Budapest Walk with Local Treats.*

DAY 3: Bratislava, Vienna

Your ship sets sail from Bratislava later this morning and heads for Vienna today. You may relax onboard all day, perhaps enjoying a drink on the Sun Deck and taking in the scenery as the ship wends its way along the Danube Bend. When you arrive in Vienna, you'll cap off your day with a private concert of Mozart and Strauss at a stunning Viennese palace. (B, L, D)

Featured Excursions: *Bratislava Small but Precious Walking Tour or "Let's Go" hike to Bratislava Castle.*

Included Night Out Excursion:
Enjoy an exclusive Mozart & Strauss concert at a historic concert hall.

DAY 4: Vienna

Vienna is a cultural treasure trove revered for its art and music (and sinfully rich pastries). Experience the "City of Waltzes" with your choice of tours, as well as an expertly led tour of an extraordinary collection of art at the renowned Vienna Art History Museum. (B, L, D)

Featured Excursions: *"Morning with the Masters" at Vienna Art History Museum and Vienna - Imperial city highlights.*

DAY 5: Dürnstein, Melk

Dürnstein is one of our favourite towns along the Danube, a lovely place to wander cobblestone lanes, browse quaint shops and maybe hike up to a ruined castle (with an intriguing tale all its own). You can also opt for a tasting or learn all about the world's costliest spice from the Wachau Valley's only saffron grower. Later, visit the 900-year-old Melk Abbey and its

extraordinary baroque-style library. You have two ports of call in the incredibly scenic valley, Dürnstein and Melk, and an assortment of delightful ways to explore this lovely region. (B, L, D)

Featured Excursions: *Choice of Dürnstein wine estate visit with tasting or Dürnstein village and saffron workshop or Melk Abbey with Library Visit or Let's Go: Biking the Wachau.*

DAY 6: Linz (Salzburg)

Mozart's birthplace of Salzburg is nestled in a glorious alpine setting that sparkles like a winter wonderland. Linz may be best known for its famous Linzer torte, but it's also a hotbed for the arts. See the sights with a local expert and visit a family at their farm in the countryside. Austria's third-largest city, Linz boasts a long history of trading and textile manufacturing, but these days it is perhaps best known for its electronic arts and annual festival. (B, L, D)

Featured Excursions: *Choice of full day Salzburg with Sound of Music, or Linz town and country: Linzertorte and cider farm visit.*

DAY 7: Passau

Passau is a crossroads in more ways than one, as three rivers meet here and three nations nearly do, making for a fascinating cultural mosaic. Get to know the town and its main claim to fame-Europe's largest pipe organ-or "Let's Go" with an invigorating riverside hike. In the evening, a special Captain's Farewell Reception and Dinner will be prepared for you. (B, L, FD)

Featured Excursions: *Choice of Passau Three Rivers or "Let's Go" Hike along the Ilz River.*

DAY 8: Passau (Disembark)

Disembark the ship and be transferred to the airport to begin your journey home. (B)

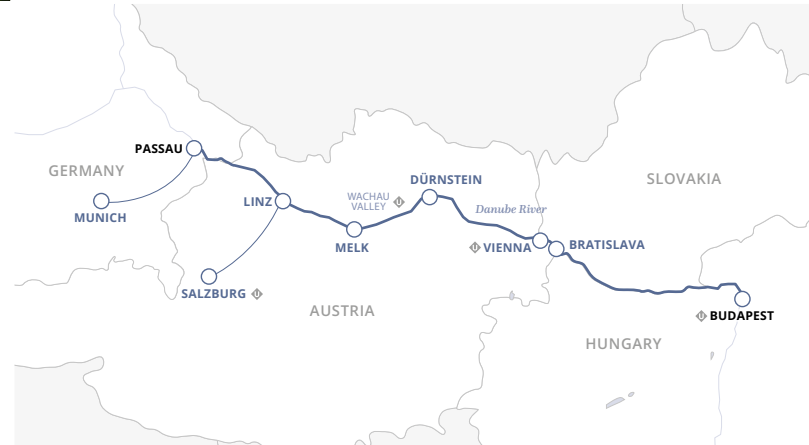

THE FINEST LUXURY AMENITIES

ON-BOARD

- Regionally inspired fine-dining through breakfast, lunch and dinner
- Unlimited premium beverages including fine-wines, locally sourced beers, handmade cocktails and top-shelf spirits
- Locally inspired onboard entertainment
- Unforgettable service from our exceptional team
- Free Wi-Fi Access
- Gratuities for onboard staff

ON LAND

- Your choice of culturally enriching shore excursions - many of which are VIP experiences unique to Uniworld
- Visit to the regions most popular landmarks including UNESCO Heritage Sites
- Airport to ship transfers
- Flights from London (regional available upon request)

— THE LUXURY — NEW YEAR SALE EVENT

Book by 31st January

2024 Spring/Autumn

Cabin Type	Was From	Now From
Classic	£2,749	£2,249

2024 Summer

Classic	£2,699	£2,199
---------	--------	--------

2025 dates and pricing now available

See our contact details below for more information

Prices shown are guide prices based on lowest lead rates and must always be checked before booking. Price shown based on two guests sharing a double occupancy cabin, including flights from London. Supplements may apply for regional airports and may vary on certain airlines. Day to day activities, inclusions and itinerary details are subject to change. Prices shown are correct at time of print, may fluctuate up or down throughout the year.

FOR THE LATEST OFFERS AND PRICING, ALWAYS CHECK WITH YOUR TRAVEL AGENT

RIVER HERITAGE CLUB MEMBERS

Past guests of Uniworld will receive an additional £150pp off this itinerary



HIGHLIGHTS OF EASTERN EUROPE

Super Ship Beatrice or River Duchess - Maximum Guests: 152

From Budapest to Bucharest, Roman ruins to medieval fortresses, this journey will reveal the unstoppable resiliency of the human spirit, as well as the highlights of this spectacular region. With highlights on every single day, this itinerary is a true showcase of Europe's fascinating history.

BUDAPEST TO BUCHAREST | DAYS: 10 | 5 COUNTRIES
INCLUDES FLIGHTS FROM LONDON

feefo Service Rating ★★★★★ Product Rating ★★★★★
342 reviews

ONCE-IN-A-LIFETIME EXPERIENCES

- Marvel at Bucharest's grand People's Palace, the second largest building in the world.



- Visit the Lepenski Vir Archeological Park, one of the largest and most significant Stone Age sites.
- Step back in time as you sail through the Iron Gates.
- Visit the Royal Grounds of Karadjordjevic Dynasty Palace in Belgrade.

DAY 1: Budapest (Embark)

Welcome to Budapest. Upon arrival, you will be greeted by a Uniworld representative to be transferred directly to your Ship to begin your luxury river cruise. (D)

DAY 2: Budapest

Located on opposite sides of the Danube, Buda and Pest each have their own distinctive character and allure. Explore this dynamic and multifaceted city with your choice of excursions—you can see it from a local's perspective on our walking tour, cover more ground with a panoramic tour. Vibrant Budapest, Hungary's capital, offers an enchanting combination of East and West. In the evening, a special Captain's Welcome Reception and Dinner will be prepared for you. (B, L, WD)

Featured Excursions: Choice of Budapest Communist Tour or Budapest Panoramic Highlights with Synagogue Visit.

DAY 3: Mohács, Batina (Osijek), Vukovar

Welcome to Croatia! This ancient country, which has made a remarkable recovery from a brutal civil war, is noted for its beautiful countryside and thriving folk traditions, as well as simple, delicious local rustic food. (B, L, D)

Featured Excursions: Choice of Vučedol Culture Museum and lunch at a family restaurant or home-hosted lunch with Karanac Craft Museum Visit.

DAY 4: Belgrade

Belgrade, the modern-day capital of Serbia, is one of Europe's oldest cities, dating back some 7,000 years. Signs of its tumultuous history are visible everywhere, juxtaposed with the city's vibrant modern-day present. (B, L, D)

Featured Excursions: Choice of Belgrade city tour with visit to the Royal Grounds of Karadjordjevic Dynasty Palace or "Let's Go" "I Bike Belgrade" tour.

Included Night Out Excursion:

This evening, enter the Cathedral of St. Sava in Belgrade to enjoy a special choir performance before enjoying a tasting of local wine and brandy.

DAY 5: Golubac, Cruising the Iron Gates

Head ashore to explore a Paleolithic site and an extraordinarily well-preserved medieval fortress. All along the way, history lines the banks of the river. Keep an eye out for Trajan's Plaque, which the ancient



Romans erected to commemorate the road they anchored in the steep cliffs above the water, and Golubac Castle, built in the 14th century and attacked successively by the Serbs, Magyars and Turks. (B, L, D)

Featured Excursions: Lepenski Vir archaeological park and Golubac Castle or "Let's Go" Hike to Golubac Castle.

DAY 6: Vidin

Vidin is a port town on the Danube that once played an important role in medieval Bulgarian politics, as the great fortress Baba Vida attests. It's your base for an unusual excursion today—a visit to the fascinating Belogradchik rock formations. Or you can head to a local's home to bake a traditional Bulgarian dish called banitzza. (B, L, D)

Featured Excursion: Choice of Belogradchik Red Rock Valley or Banitzza home baking experience or Bononia Wine Estate & Tasting.

DAY 7: Ruse

Bulgaria's foremost Danube port, Rouse is sometimes called "Little Vienna" for its elegant 19th-century mansions and public buildings. In the evening, a special Captain's Farewell Reception and Dinner will be prepared for you. (B, L, FD)

Featured Excursions: Choice of Veliko Tarnovo and Arbanassi with authentic Bulgarian lunch or Ruse walking tour with Ivanovo and Basarbovo monasteries.

DAY 8: Giurgiu (Disembark, Transfer to Bucharest)

This morning, you'll disembark the ship in Giurgiu and drive through the countryside to Bucharest, where you'll enjoy a panoramic city tour and a visit to People's Palace. Tonight, you'll relax in the comfort of a luxury hotel located in the heart of the city, Romania's capital and its cultural and economic centre. (B)

Featured Excursion: Bucharest Communist Tour with People's Palace.

DAY 9: Bucharest

Get to know the bustling heart of Romania's capital city with a full day to explore Bucharest on your own. (B)

DAY 10: Bucharest (Disembark)

Disembark the ship and be transferred to the airport to begin your journey home. (B)

THE FINEST LUXURY AMENITIES

ON-BOARD

- Regionally inspired fine-dining through breakfast, lunch and dinner
- Unlimited premium beverages including fine-wines, locally sourced beers, handmade cocktails and top-shelf spirits
- Locally inspired onboard entertainment
- Unforgettable service from our exceptional team
- Free Wi-Fi Access
- Gratuities for onboard staff

ON LAND

- Your choice of culturally enriching shore excursions - many of which are VIP experiences unique to Uniworld
- Visit to the regions most popular landmarks including UNESCO Heritage Sites
- Airport to ship transfers
- Flights from London (regional available upon request)

— THE LUXURY —
NEW YEAR SALE EVENT

Book by 31st January

2024 Spring/Autumn

Cabin Type	Was From	Now From
Classic	£3,999	£3,499

2024 Summer

Classic	£4,099	£3,599
---------	--------	--------

2025 dates and pricing now available
See our contact details below for more information

Prices shown are guide prices based on lowest lead rates and must always be checked before booking. Price shown based on two guests sharing a double occupancy cabin, including flights from London. Supplements may apply for regional airports and may vary on certain airlines. Day to day activities, inclusions and itinerary details are subject to change. Prices shown are correct at time of print, may fluctuate up or down throughout the year.

FOR THE LATEST OFFERS AND PRICING, ALWAYS CHECK WITH YOUR TRAVEL AGENT

RIVER HERITAGE CLUB MEMBERS

Past guests of Uniworld will receive an additional £150pp off this itinerary

EXPLORE OUR SPECTACULAR JOURNEYS OF THE WORLD

*Combine the finest escorted land tours with a luxury
river cruise for a once-in-a-lifetime experience*



INTRODUCING OUR SPECTACULAR JOURNEYS OF THE WORLD

We've combined the finest land tours with our very own luxury river cruise to create a series of bucket-list adventures throughout India, Egypt, Southeast Asia and Peru. These once-in-a-lifetime journeys are the ideal way to travel long-haul in five-star luxury.



Amber Fort, India



THE BEST OF SOUTHEAST ASIA

Two of the most beautiful, historic and friendly places in all of Asia; Vietnam and Cambodia combined into one fascinating and rewarding adventure. Sail along the iconic Mekong River and explore iconic cities such as Ho Chi Minh and Siem Reap before visiting Angkor Wat to tick off your bucket list.



SPLENDOURS OF EGYPT & THE NILE

An enchanting land of marvels, myths, and wonders of the old and new, Egypt is an extraordinary destination no culturally curious traveller will want to miss. You'll visit the burial grounds of Egyptian royalty before sailing down the Nile in a manner once reserved for queens and pharaohs.



INDIA'S GOLDEN TRIANGLE AND SACRED GANGES

Complex and beguiling, India is a country unlike any other. No trip to India would be complete without a visit to the iconic Golden Triangle, featuring the very best Delhi, Jaipur and Agra has to offer. Following your escorted land tour you will set sail down the sacred Ganges river. You can expect vibrant colours, bustling markets and unforgettable moments in this bucket-list journey.



THE BEST OF PERU & AMAZON RAINFOREST

With no shortage of awe-inspiring beauty, your journey through Peru is sure to be an unforgettable adventure. After exploring Lima, you will venture deep into the Amazon Rainforest, paying a visit to endless nature reserves and admiring the ever-changing scenery. Of course, no trip to Peru could truly be complete without a trek to the world-famous Machu Picchu.

SAIL IN THE ULTIMATE STYLE

Unrivalled Luxury, only with Uniworld

A Uniworld river cruise is far more than a cruise; it's a journey showcasing the very best a destination or region has to offer. Whether you are celebrating a special occasion or simply prefer to travel the world's rivers in unrivalled luxury, our boutique floating hotels and immersive itineraries combine for the perfect luxury getaway.



A RIVER CRUISE LIKE NO OTHER

Every element of your cruise with Uniworld is designed to be truly like no other, filled with moments and highlights not available anywhere else. From the ships you sail on, to the excursions you enjoy and even the incredible culinary options available with every meal. After all, every guest deserves the best.

FLOATING BOUTIQUE HOTELS

As the only river cruise line globally, that owns and operates a collection of luxury hotels, Uniworld is entirely unique within the industry. We've followed in the footsteps of our sister brand, the Red Carnation Hotel Collection to design our ships as floating boutique hotels sailing along the world's most iconic waterways.

THE VERY BEST CULINARY EXPERIENCES

Prepare for a culinary journey like no other. As you sail from one destination to the next, our industry-leading team of Executive chefs will serve the finest cuisine available on the world's rivers - always made using the freshest ingredients sourced from local distributors.

UNFORGETTABLE SERVICE

No matter how or where you travel in the world, the one thing you always look back on is the level of service you receive. Our family of staff are known throughout the industry for providing a true level of luxury service to every guest.

STAY IN THE WORLD'S FINEST HOTELS & RESORTS

on your Long-Haul Adventures with Uniworld

THE WORLD RENOWNED OBEROI HOTEL COLLECTION

India

The Oberoi Hotels are renowned for being among the finest in India, offering world-renowned service to every guest they welcome. Your Indian adventure begins with five luxurious nights across three of their breathtaking hotels, based in New Delhi, Jaipur, and Agra—just 600 meters from the Taj Mahal!



FOUR SEASONS CAIRO

Egypt

In the heart of Cairo on the banks of the River Nile, the Four Seasons Cairo opens the door to discovering Egypt's 5,000-year-old ancient mysteries. Just a short drive away, set out to explore the majestic pyramids, the 1,000-year old market, the 12th-century citadel and the ancient Egyptian museum.

SOFITEL ANGKOR PHOKEETHRA GOLF & SPA RESORT

Cambodia

Just ten minutes away from the famed monuments of Angkor Wat, French colonial elegance sits amidst the manicured gardens of Sofitel Angkor Phokeethra Golf & Spa Resort. A lavish swimming pool beloved by guests is surrounded by lush and opulent landscaping. This hotel is the most heavily awarded resort in Siem Reap.

PARK HYATT SAIGON HO CHI MINH CITY

Vietnam

Complete with sophisticated design, handcrafted details, and modern-day comforts, the Park Hyatt Saigon is an excellent partner to a Uniworld cruise. Much like Uniworld, Park Hyatt pride themselves on giving every guest truly unbeatable service.



LUXURY RAIL & CRUISE JOURNEYS

A whole new way to travel with Uniworld

We've partnered with two different five-star luxury train brands to craft extraordinary journeys of river cruising, land and train travel. As a pre- or post-cruise addition to your time sailing in all-inclusive luxury with Uniworld, you'll embark on one of the best private train experiences the world has to offer.



THE PERFECT PAIRING

Everchanging views, visiting a variety of destinations in one trip without having to pack up every time and having everything taken care of for you—all benefits of river cruising, and all reasons to love train travel too.



OUR LUXURY RAIL PARTNERS

We're thrilled to partner with *Golden Eagle* and *The Maharajas' Express* for Cruise & Rail journeys that bring the Uniworld standard of luxury to the private train experience. And of course, it's all-inclusive.



DINING

Feast on delicious cuisine representing a variety of local and international flavours, served with fine wines onboard, and occasionally head into town for unique included dining experiences.



ACCOMMODATIONS

Pair your boutique floating hotel with a luxurious gliding hotel, where your en-suite cabin is an elegant private compartment during the day and transforms into a comfortable bedroom for the evening.



REPUBLICS OF THE SILK ROAD

Luxury Rail Journey

Golden Eagle Luxury Train - Almaty to Tashkent - 14 days

Journeying aboard the Golden Eagle, we will travel through the magnificent "Five Stans". From the magnificent mosques and bustling bazaars of Uzbekistan and Turkmenistan to the breath-taking verdant expanse and ethereally tranquil landscapes of Tajikistan and Kazakhstan, this incredible 14-day adventure is your invitation to one of the world's greatest train journeys.



Samarkand, Uzbekistan



Golden Eagle Luxury Train



CASPIAN ODYSSEY

Luxury Rail Journey

Golden Eagle Luxury Train - Yerevan to Almaty - 16 days

Embark on a pilgrimage through paradise, with this 16-day immersive showcase of the mysticised lands of the Caspian Sea. From Armenia to Kazakhstan, this epic adventure heads east through a magnificent backdrop of majestic medieval cities, breath-taking archaeological architecture, and palatial Islamic masterpieces.



The monastery of Geghard



Golden Eagle Luxury Train



Travel on the luxurious Golden Eagle Train

2024 & 2025 Departures

Pricing details coming soon! Contact us or your travel agent for more information.

EVERY LUXURY INCLUDED

- Five-star pre and post tour hotel accommodation
- Private en-suite accommodation on the Golden Eagle train
- Freshly prepared meals on board, using the finest local ingredients
- Generous drinks allowance, including international wines with lunch and dinner
- All transfers and transportation
- Expertly guided off-train excursions as detailed in the itinerary
- See the Darvaza Burning Gas Crater light up the night sky in the Kara Kum desert
- Explore the historic, UNESCO honoured, cities of Khiva, Merv, Bukhara and Samarkand



Explore Baku, Azerbaijan

2024 & 2025 Departures

Pricing details coming soon! Contact us or your travel agent for more information.

EVERY LUXURY INCLUDED

- 2-night hotel stay at the five-star Four Seasons, Baku (or similar)
- Private en-suite accommodation on the Golden Eagle train
- Freshly prepared meals on board, using the finest local ingredients
- Generous drinks allowance, including international wines with lunch and dinner
- All transfers and transportation
- Expertly guided off-train excursions as detailed in the itinerary
- Visit the monastery of Geghard, the cultural centre of medieval Armenia
- Sample delicious Georgian wine in the renowned wine-making region of Kakheti

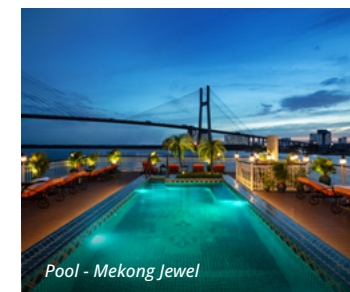

TIMELESS WONDERS OF VIETNAM, CAMBODIA & THE MEKONG

Mekong Jewel - Maximum Capacity: no more than 68 guests

Two of the most beautiful, historic and friendly places in all of Asia. In many ways, a visit here is less about the sights you see than it is about the people you meet and the experiences you have along the way.



HO CHI MINH CITY TO HANOI | DAYS: 15 + 2 DAYS TRAVEL
2 COUNTRIES | INCLUDES FLIGHTS FROM LONDON

feefo Service Rating **Product Rating**
177 reviews ★★★★★ ★★★★★

ONCE-IN-A-LIFETIME EXPERIENCES

The best of Vietnam & Cambodia

Angkor Wat Temple

- The largest religious monument in the world, the magnificent Angkor Wat is the single most recognisable landmark in Cambodia. It is simply breathtaking in both size and scope and boasts the longest continuous bas-relief in the world.

Cambodia's Killing Fields

- Prepare for the most profound and memorable experience you may ever have experienced as you visit the famous killing fields located near Phnom Penh.

Aspara Show and Dinner

- Indulge in a lavish dinner with an Apsara dance show. Apsara is the traditional Khmer dance form that tells stories and conveys messages using ornate costumes.

Sailing the Mekong

Daily Life on the Great Delta

- Step aboard a sampan to experience the true life along the great delta, where you will visit floating villages that depend on the river for survival.

Unforgettable Water Blessing

- Before your departure you'll receive a traditional water blessing from the local monks-one of the most personal and touching moments you'll experience on this journey.

Local Cambodian Village Visits

- An incredibly warming and moving day awaits as you pay a visit to local villages dotted along the Mekong. Deepen your understanding of Cambodia when you meet villagers in their homes and prepare to answer plenty of questions when you visit a local school-because the children love to practice their English.



Grand Suite - Mekong Jewel



Scan code to watch a video about this cruise

TRAVEL IN THE ULTIMATE STYLE

Southeast Asia's Best Hotels Park Hyatt Saigon

- Discover urban luxury with a combination of sophisticated design, handcrafted details, and modern-day comforts, the perfect base whilst you explore Ho Chi Minh City.

Sofitel Angkor Phokeethra Golf & Spa Resort

- Located just ten minutes away from the famed monuments of Angkor Wat, this hotel is widely regarded as one of the finest hotels in Cambodia. With a serene design reflecting French sophistication, it's no wonder this hotel is the most awarded in Siem Reap.

Sofitel Legend Metropole Hanoi Hotel

- Savour the French art de vivre blended with elegant Vietnamese touches during your two night stay in the heart of Hanoi.

Mekong Jewel (New in 2020)

All Suite Ship

- No matter what stateroom category you opt for, you will enjoy all the luxuries only a Uniworld suite has to offer. With only 34 suites onboard, you are sure to receive the very best service from our fantastic crew onboard.

The Finest Amenities

- Beautiful indoor and outdoor lounges, a remarkable top-deck pool, two dining venues and a relaxing wellness centre complete with a nail and hair bar await you onboard. Everything onboard has been made using only sustainable and eco-friendly materials.

The Best way to Sail the Mekong

- This incredibly spacious, multi-story ship will have you charmed by your surroundings from the moment you step onboard. The onboard artwork is inspired by the very landscapes you will sail past.

DAY 1: Ho Chi Minh City

Upon arrival at Tan Son Nhat International Airport, you will be greeted by a Uniworld representative and transferred to the Park Hyatt Saigon. Tonight, consider popping out to explore the lively Ben Thanh Night Market or one of the city's quintessential evening cafés—either choice would mark a splendid start to your adventure. (B, WD)

DAY 2: Ho Chi Minh City

Experience how ancient history melds with the boisterous present in Vietnam's largest city, where skyscrapers tower over ancient temples and motorbikes putter along picturesque alleys. (B, L, D)

Featured Excursion: *Dynamic Ho Chi Minh City.*

DAY 3: Ho Chi Minh City, Transfer, My Tho (Embark), Tien Loi (Ben Tre)

Today's featured excursion provides a fascinating glimpse of the Viet Cong's vast network of incredibly narrow tunnels dating back to the Vietnam War. Following lunch, you'll be taken to the *Mekong Jewel*. (B, L, D)

Featured Excursion: *Vestiges of war - Cú Chi Tunnels.*



Ho Chi Minh City



Explore the Cú Chi Tunnels

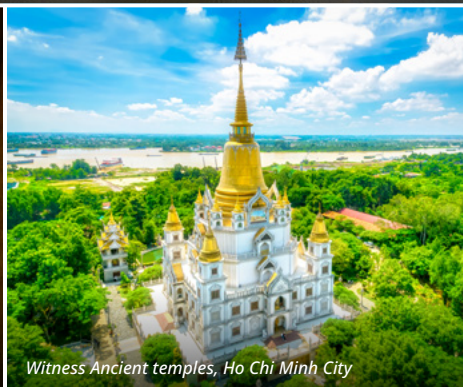

Witness Ancient temples, Ho Chi Minh City



Royal Suite - Mekong Jewel



Mekong Jewel cruising on the Mekong river



Cambodian monks

DAY 4: Tien Loi (Ben Tre), Vinh Long, Sa Dec

Today, you'll witness the hustle and bustle of delta river life as the local traders take their produce to market. After breakfast, you'll board a traditional sampan and explore the narrow canals and backwaters of this famed region. The untouched island of Tien Loi awaits a unique excursion created exclusively for Uniworld guests, where you can see how local farmers make rooster cages, decorate bonsais in their yards and more. Upon arrival to Vinh Long, your sampans will bring you to a traditional rice factory. Back onboard, savour an authentic Vietnamese meal this evening. (B, L, D)

Featured Excursion: *Step aboard a luxurious sampan to discover the village life along the Mekong.*

DAY 5: Sa Dec, Gieng Island, Hong Ngu, Cruising the Mekong River

Following breakfast, continue your journey via sampan, where you'll observe the daily routines of the villagers in Sa Dec. Visit a colourful temple, the home of Mr. Huynh Thuy Le and then venture to Gieng Island, where you'll experience how a local family makes incense sticks and the conical hat. (B, L, D)

Featured Excursion: *Sampans and romance.*

DAY 6: Hong Ngu (Long Khanh A), Cruising the Mekong River, Phnom Penh

Visit the local island village of Hong Ngu, a major producer of the traditional Khmer scarves located not far from the Vietnam-Cambodia border. Since they're woven in many homes around the village, you'll have the opportunity to see the process first-hand. You'll also stop at a local temple dedicated to a unique religion founded in this area of Vietnam, Hoa Hoa. Your last and most interesting visit of the day? A visit to the local home of a retired VC General. (B, L, D)

Featured Excursion: *Daily life on the great delta.*

DAY 7: Phnom Penh

Today, you'll discover the thriving and exotic capital of the Kingdom of Cambodia, Phnom Penh. It stands at the juncture of three captivating rivers and is divided into three districts, the picturesque French colonial area, a handsome residential district and a rapidly changing Old Town. Here, you'll find an alluring riverside esplanade amid numerous bewitching Buddhist temples, palaces and artefacts. (B, L, D)

Featured Excursion: *Cambodia's capital-Phnom Penh.*



Phnom Penh



Explore the floating markets along the Mekong

DAY 8: Phnom Penh, Cruising the Mekong River, Angkor Ban

Today's featured excursion may be the most profound and memorable experience of your entire journey. You'll learn about the infamous Killing Fields of the Khmer Rouge and visit a former school-turned-prison that is now a genocide museum. (B, L, D)

Featured Excursion: *The Killing Fields—tragedy and reconciliation in Cambodia.*

DAY 9: Angkor Ban, Wat Hanchey, Kampong Cham

If yesterday was an exploration of Cambodia's dark past, today is a celebration of the country's bright future. You'll meet young children at a local school and friendly villagers in their homes, and have a rare opportunity to receive an unforgettable water blessing from local Buddhist monks. (B, L, D)

Featured Excursion: *Cambodia's vibrant cultural life.*

DAY 10: Kampong Cham (Disembark), Transfer, Siem Reap

You'll disembark in the morning and transfer via executive motorcoach to Siem Reap, the gateway to Angkor, the legendary archaeological site. You will enjoy three nights at the Sofitel Angkor Phokeethra Golf & Spa Resort, minutes away from the famed temple complex of Angkor Wat. (B, L)

Featured Excursions: *City tour & Artisan visit by remark.*



Angkor Thom, Siem Reap

DAY 11: Siem Reap

Today is a bucket list kind of day as you explore the ancient temples of Angkor Wat, a gigantic religious complex that is now a UNESCO World Heritage Site. (B)

Featured Excursion: Angkor Wat Temple.

DAY 12: Siem Reap

Today you will enter the spectacular remnants of Angkor Thom, the royal city. Built during the heyday of the Khmer dynasty in the 12th century, this extraordinary complex of Hindu and Buddhist monuments was once lost to the world for many years, hidden under dense jungle vines. (B, FD)

Featured Excursions: South gate of Angkor Thom, Bayon and Ta Prohm and Apsara show and dinner.



Angkor Wat, Siem Reap

DAY 13: Siem Reap, Fly to Hanoi

Enjoy free time in Siem Reap before your flight to Hanoi. Then, check in to your luxury accommodations, the Sofitel Legend Metropole Hanoi Hotel. (B)

DAY 14: Hanoi

Parisian elegance infuses Hanoi's boulevards, which are lined with handsome colonial buildings, as you'll see on today's fascinating tour of the city. (B, L, D)

Featured Excursion: Hanoi City Tour.

DAY 15: Hanoi

Check out of your luxury hotel and head to the airport for your flight home. (B)



Sofitel Legend Metropole Hanoi Hotel



Hanoi

— THE LUXURY —
NEW YEAR SALE EVENT
 Book by 31st January

2024 Departures

Cabin Type	Was From	Now From
Royal Suite	SOLD	OUT
Grand Suite	-	£9,279
Suite	-	£6,379

2025 Departures

Royal Suite	£11,599	£10,439
Grand Suite	£10,299	£9,269
Suite	£7,499	£6,749

Prices shown are per person guide prices based on lowest lead in rates and must always be checked before booking. Price shown based on two guests sharing a double occupancy cabin, including flights from London. Supplements may apply for regional airports and may vary on certain airlines. Day to day activities, inclusions and itinerary details are subject to change. Prices shown are correct at time of print, may fluctuate up or down throughout the year.

FOR THE LATEST OFFERS AND PRICING, ALWAYS CHECK WITH YOUR TRAVEL AGENT

RIVER HERITAGE CLUB MEMBERS

Past guests of Uniworld will receive an additional £350pp off this itinerary

Extend your Stay in Southeast Asia

TIMELESS WONDERS OF VIETNAM, CAMBODIA & THE MEKONG WITH HA LONG BAY

HANOI TO HANOI - 18 DAYS

According to local legend, Ha Long Bay was formed by the thrashing tails of dragons that were sent by the gods to help the Vietnamese people defend their land from invading Chinese forces. According to scientists, it was created by millions of years of erosion and geological evolution. No matter how it was fashioned, Lan Ha Bay is a unique wonder of the natural world—a precious open-air geological museum and UNESCO World Heritage Site. An exploration of the bay and its islands is the perfect way to launch your Mekong River adventure.



Kayaking around the beautiful Ao Ech area

2024 & 2025 Departures
 For dates and pricing details contact us below

Solo Travellers
 To discuss solo traveller options please contact us

EVERY LUXURY INCLUDED

- 1 night at the Sofitel Legend Metropole Hanoi Hotel (or similar)
- 2 nights on the Paradise Grand Junk, Ha Long & Lan Ha Bays with all meals onboard
- Breakfast daily and all service charges, taxes and portorage
- Viet Hai Village Visit
- Discover natural lagoons in Lan Ha Bay
- All transfers and transportation
- Plus all the luxury amenities showcased on pages 62-66



Ha Long Bay, Vietnam

EVERY LUXURY INCLUDED

- | | |
|--|--|
| <p>ON-BOARD</p> <ul style="list-style-type: none"> • Complimentary house wine, local spirits and beer served throughout the cruise. • Best Dining Experiences on the World's Rivers • Welcome and Farewell Gala Dinners • Locally inspired onboard entertainment • Sail the Mekong in ultimate style and experience local life • Free Wi-Fi access • All on board gratuities | <p>ON LAND</p> <ul style="list-style-type: none"> • Discover iconic cities such as Ho Chi Minh, Phnom Penh, Siem Reap and Hanoi • Explore the famed Cú Chi tunnels • Visits to multiple UNESCO World Heritage Sites • Be in awe during a visit to Angkor Wat • Enjoy a dinner with an Aspara Dance • All internal flights throughout • Return flights from London Heathrow |
|--|--|



5
AS SEEN
ON CRUISING
WITH JANE
MCDONALD



Scan code to watch a video about this cruise



Amber Fort



Maharaja Suite - Ganges Voyager II



Governors Lounge - Ganges Voyager II

INDIA'S GOLDEN TRIANGLE & THE SACRED GANGES

Ganges Voyager II - Maximum Capacity: no more than 56 guests

This once-in-a-lifetime experience will take you on a journey through some of the most beautiful and historical places in India. Explore India's famed Golden Triangle, complete with five night's staying in India's most luxurious hotels before sailing down the Sacred river Ganges in unrivalled five-star luxury.



NEW DELHI TO KOLKATA | DAYS: 13 + 2 DAYS TRAVEL | 1 COUNTRY
INCLUDES FLIGHTS FROM LONDON

feefo
142 reviews

Service Rating
★★★★★

Product Rating
★★★★★

ONCE-IN-A-LIFETIME EXPERIENCES

India's Golden Triangle Delhi

- Explore India's sprawling capital city like a true local as you step aboard a rickshaw to ride into Old Delhi. Take in the passing sights before spending some free time exploring the city on your own.

Agra

- The city of Agra is home to arguably the world's most famous landmark, the remarkable Taj Mahal. Over two days you will have the opportunity to experience it once at sunset and again the next morning during sunrise, without the usual crowds.

Jaipur

- The pink city of Jaipur is filled with magical surprises. Highlights of your visit here includes the Amber Palace and the Jantar Mantar, a UNESCO World Heritage site devoted to astronomy.

Cruising the Ganges Kolkata

- Highlights in Kolkata include a visit to Mother Teresa's home, admiring the remaining colonial architecture plus visiting a captivatingly colourful flower market.

Kalna

- India's "Temple City" - best known for the magnificent Hindu temples built by the maharajas of Bardhaman. For the best view, glide through the city on a pedal-powered three-wheeled rickshaw, known as a trishaw locally.

Experience Rural Life

- Set sail on one of the world's most sacred bodies of water as you sail through a myriad of small villages dotted along the river. Here you will experience the true local life not many travellers get to see.



The Oberoi Amarvilas, Agra

TRAVEL IN THE ULTIMATE STYLE

The World Renowned Oberoi Hotels

The Oberoi New Delhi

- Enjoy unrestricted views of the UNESCO World Heritage Site of Humayun's Tomb on one side and a calming view of a forested golf course on the other.

The Oberoi Amarvilas, Agra

- This breathtaking hotel is located just 600 metres from the Taj Mahal, offering every Uniworld guest an unrestricted view of the world-renowned landmark.

The Oberoi Rajvilas, Jaipur

- The Oberoi Rajvilas. Spread over 1,29,499 square metres of beautifully landscaped gardens, with traditional architecture, flaming Mashaal torches and reflection pools.

Cruising onboard the Ganges Voyager II

All Suite

- This all-suite ship is the perfect way to sail along the sacred Ganges river. The spacious, high-ceilinged suites are a serene sanctuary, complete with all the comforts of a five-star hotel.

Locally Inspired Decor

- With beautiful hand-painted murals located in every suite, the Ganges Voyager II is a showcase of the very best of India.

Maximum of 56 Guests

- With a maximum capacity of 56 guests (28 suites), this ship offers an intimate and relaxing atmosphere throughout.

DAY 1: New Delhi

Upon arrival at Delhi airport, you will be greeted by a Uniworld representative and transferred to the newly renovated Oberoi New Delhi hotel. (B, D)

DAY 2: New Delhi

India's sprawling capital city is colourful, confounding and captivating. Your expertly led city tour provides an ideal first foray into this fascinating land. To cap your day taking in the sights of scenic New Delhi, relax this evening over a delicious dinner at the Oberoi. (B, L, D)

Featured Excursion: India's capital city with rickshaw ride to Old Delhi.

DAY 3: New Delhi, Agra

This morning you will check out of your New Delhi hotel and head south via motorcoach to Agra, the site of Shah Jahan's best-known building project, the exquisite Taj Mahal. You'll visit the Taj Mahal this afternoon and stay for sunset, as the monument's changing colours draw comparisons to the shifting mood of the late Emperor's wife. (B, L)

Featured Excursion: Majesty and grace—the Taj Mahal at sundown.



Oberoi, New Delhi

DAY 5: Jaipur

Pink is the colour of hospitality in Rajasthan, which gives you an idea of what to expect in the "Pink City" of Jaipur. Take the afternoon to explore on your own—shuttles will be available to carry you to and from the hotel to the city's shopping district. (B)

Featured Excursion: Jaipur's princely city and Amber Fort.

DAY 6: Jaipur, Kolkata (Embark)

Settle into your beautifully appointed suite aboard the Ganges Voyager II in Kolkata. (B, L, WD)

DAY 7: Kalna

Kalna, once an important trade port on the river, is best known today for the magnificent Hindu temples built by the maharajas of Bardhaman— which you'll experience today. After marvelling at the astonishing Rajbari temple complex, you may opt to walk with your guide through the colourful local market. (B, L, D)

Featured Excursion: India's "Temple City."

DAY 8: Matuari

Your ship serves as a time machine today, transporting you hundreds of years into the past, as we travel to the authentic artisan village of Matuari. (B, L, D)

Featured Excursion: Matuari master craftsmen with an introduction to brass.

DAY 9: Murshidabad, Baranagar

Today's adventures take you to a duo of Bengali towns—Murshidabad and Baranagar—each one boasting surprising and beautiful architectural monuments closely linked to the ruling families of the area. (B, L, D)

Featured Excursion: Visit to Murshidabad City, ride by buggy to Katra Mosque and visit to Baranagar village.



Kalna



Rajasthani folk dance



Early morning at the Taj Mahal, India

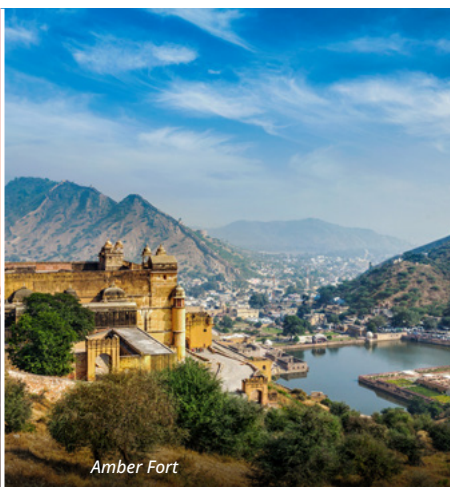

Amber Fort



Viceroy Suite - Ganges Voyager II

DAY 4: Agra, Jaipur

Is the Taj Mahal best seen at sunset or sunrise? It's an impossible question to answer, so Uniworld guests have the rare pleasure of experiencing both. Wake up early this morning to see the white marble monument aglow with the rosy tinge of dawn. You'll spend your next two nights at the beautiful Oberoi Rajvillas. The luxury hotel sits on 32 acres of landscaped gardens and is built around an ancient Shiva temple. (B, L, D)

Featured Excursion: Early morning at the Taj Mahal.

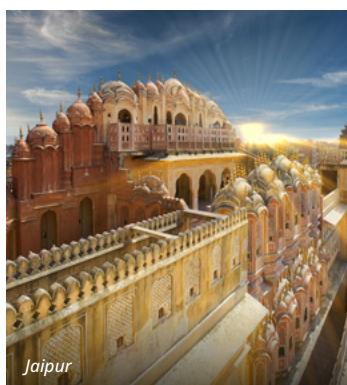

Jaipur



The Oberoi Rajvillas

DAY 10: The Ganges

One of the world's most sacred bodies of water, the Ganges River flows through a myriad of small villages and highly populated cities throughout India and Bangladesh. Take in the remarkable scenery as you sail and be on the lookout for a rare sighting of the endangered Ganges river dolphin. Also today, watch as a skilled practitioner of mehndi demonstrates how the intricate henna patterns are created, and discover the meanings of the traditional motifs. (B, L, D)

Featured Excursion: Khusbagh Walk.

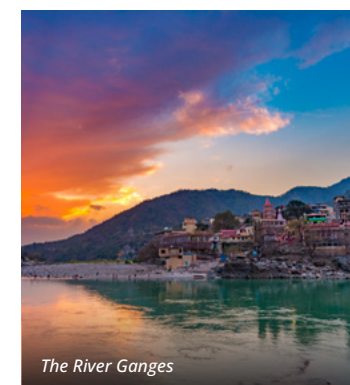

The River Ganges

DAY 11: Mayapur, Chandannagar

Few places of worship exist on such a head-spinning scale as what you will witness today in Mayapur, the centre of the international Hare Krishna movement and home to the new Temple of the Vedic Planetarium, still under construction. This evening, enjoy a Farewell dinner and take in a lively cultural dance performance, complete with music and dancing. (B, L, D)

Featured Excursions: Hare Krishna complex and Temple of the Vedic Planetarium and India's French colonial heritage.

DAY 12: Kolkata

The city of Kolkata is synonymous with the enduring legacies of Mother Teresa and the colonial-era British Raj, both of which you will get better acquainted with today. (B, L, FD)

Featured Excursions: Kolkata city tour- visit the Flower Market, colonial sites and Kumartulli. Plus, your choice of NGOs Kolkata Rescue visit or Mother Teresa's home and tomb.

DAY 13: Kolkata (Disembark)

Your incredible Indian adventure ends early this morning, as you disembark and transfer to the Netaji Subhas Chandra Bose International Airport for your flight home or extend your journey with an optional extension to Varanasi. (B)



Visit the vibrant Kolkata Flower Market



Kolkata

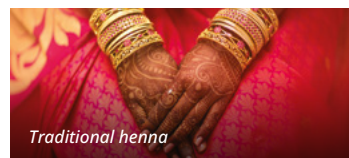

Traditional henna

— THE LUXURY —
NEW YEAR SALE EVENT
Book by 31st January

2024 Departures

Cabin Type	Was From	Now From
Heritage Suite	-	£8,379
Colonial Suite	-	£6,979
Signature Suite	-	£6,379

2025 Departures

Heritage Suite	£8,899	£8,009
Colonial Suite	£7,499	£6,749
Signature Suite	£6,999	£6,299

Prices shown are per person guide prices based on lowest lead in rates and must always be checked before booking. Price shown based on two guests sharing a double occupancy cabin, including flights from London. Supplements may apply for regional airports and may vary on certain airlines. Day to day activities, inclusions and itinerary details are subject to change. Prices shown are correct at time of print, may fluctuate up or down throughout the year.

FOR THE LATEST OFFERS AND PRICING, ALWAYS CHECK WITH YOUR TRAVEL AGENT

RIVER HERITAGE CLUB MEMBERS

Past guests of Uniworld will receive an additional £450pp off this itinerary

EVERY LUXURY INCLUDED

ON-BOARD

- Complimentary house wine, local spirits and beer served throughout the cruise.
- Best Dining Experiences on the World's Rivers
- Stay onboard the 28 suite ship Ganges Voyager II
- Welcome and Farewell Gala Dinners
- Locally inspired onboard entertainment
- Cruise the sacred Ganges river and experience local life
- Free Wi-Fi access
- All on board gratuities

ON LAND

- Immersive and inspiring shore excursions in every port of call, many of which exclusive to Uniworld
- Exclusive early morning visit to the Taj Mahal
- Visits to 4 UNESCO World Heritage Sites
- Unforgettable Rickshaw ride in New Delhi
- Visit Mother Teresa's Home in Kolkata
- Marvel at the pink city of Jaipur
- Airport to ship transfers
- All internal flights throughout
- Return flights from London Heathrow

Extend your Stay in India

INDIA'S GOLDEN TRIANGLE & THE SACRED GANGES WITH VARANASI

VARANASI TO NEW DELHI- 15 DAYS

The sacred city of Varanasi is known as the city of temples and a beacon of culture, a 3 day pre or post cruise extension is the perfect way to start or end to your luxury journey through India. Come for the beautiful temples and explore the stunning silk weaved locally.



2024 & 2025 Departures
For dates and pricing details contact us below

Solo Travellers
To discuss solo traveller options please contact us

EVERY LUXURY INCLUDED

- 1 night at the Taj Ganges, Varanasi (or similar)
- 1 night at the Trident Hotel, Gurgaon (or similar)
- Breakfast daily, 1 lunch, 1 dinner
- All service charges, taxes and portorage
- Varanasi panoramic city tour with private boat viewing of an Aarti ceremony at sunset
- Private boat viewing of life and rituals on the Ganges at sunrise and silk factory visit
- All transfers and transportation
- Flights from Kolkata to Varanasi and Varanasi to New Delhi
- Plus all the luxury amenities in India showcased on pages 68-72

INDIA'S GOLDEN TRIANGLE & THE SACRED GANGES WITH UDAIPUR

UDAIPUR TO NEW DELHI - 16 DAYS

Often referred to as the 'Venice of the East', the city of lakes Udaipur is located around azure water lakes and is hemmed in by lush green hills of Aravallis. You'll stay in the beautiful Taj Lake Palace hotel, a truly remarkable property offering an unforgettable travel experience.



2024 & 2025 Departures
For dates and pricing details contact us below

Solo Travellers
To discuss solo traveller options please contact us

EVERY LUXURY INCLUDED

- 1 night at the Trident Hotel, Gurgaon (or similar)
- 2 nights in Udaipur at the Taj Lake Palace (or similar)
- Breakfast daily, 2 lunches, 1 dinner
- All service charges, taxes and portorage
- Udaipur city tour and visit to Lake Pichola and the garden of Saheliyon Ki Bari
- All transfers and transportation
- Flights from Kolkata to Udaipur and Udaipur to New Delhi
- Plus all the luxury amenities in India showcased on pages 68-72



Lounge - Super Ship Sphinx



Sun Deck - Super Ship Sphinx

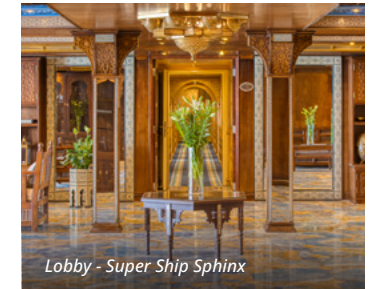

Lobby - Super Ship Sphinx

SPLENDOURS OF EGYPT & THE NILE

Super Ship Sphinx or River Tosca - Maximum Capacity: no more than 84 guests

Prepare for the experience of a lifetime as you journey through ancient Egypt. Our exceptional service, gourmet dining, and elegant accommodations aboard one of our state-of-the-art river ships will make your trip truly unforgettable. With a host of exclusive excursions to Egypt's most iconic landmarks and historic sites included, you're sure to be amazed.



CAIRO TO CAIRO | DAYS: 12 | 1 COUNTRY
INCLUDES FLIGHTS FROM LONDON

feefo Service Rating Product Rating
486 reviews ★★★★★ ★★★★★

ONCE-IN-A-LIFETIME EXPERIENCES

The best of Egypt

Cairo Egyptian Museum

- It's by far the most impressive collection of Egyptian antiquities and pharaonic treasures in the world. Located in the heart of Cairo, the museum displays an astonishing number of objects.

The Great Pyramids

of Giza & the enigmatic Sphinx

- Venture to ancient Memphis, a UNESCO World Heritage Site with a number of amazing monuments to see-including the Great Pyramids and enigmatic Sphinx.

Visit Endless Temples

- With visits to legendary temples of Karnak, Luxor and Hathor included as you journey along the Nile, you are sure to be left speechless by the sheer size of the ruins that stand in front of you.

Sailing the Nile

Afternoon Tea at the Old Cataract Hotel

- Step into a colonial-era hotel for one of the finest afternoon teas available. Former guests include Winston Churchill and Princess Diana, plus its widely known Agatha Christie stayed here whilst writing her mystery novel, *Death on the Nile*.

The Valley of the Kings

- You'll visit one of the most famous archaeological sites in the world-the remote and barren Valley of the Kings, once used for royal burials for nearly 500 years. Much of our understanding of Egyptian mythology has been garnered from these ancient chambers.

Bird-Watching Along the Nile

- Take a small boat along the banks of the Nile on a bird-watching excursion. Watch out for colourful native birds, different species of herons, kingfishers, vultures, sunbirds and other wildlife that thrive along the riverbank.



Restaurant - Super Ship Sphinx

TRAVEL IN THE ULTIMATE STYLE

Stay in Cairo's Best Hotels

Four Seasons Cairo

- When travelling onboard the Super Ship Sphinx, guests will enjoy four nights staying in the Four Seasons Cairo. Situated on the banks of the Nile, this hotel is one of the most luxurious in the city of Cairo.

OR

The Nile Ritz-Carlton

- When travelling onboard the River Tosca, guests will check in for a luxury stay at The Nile Ritz-Carlton hotel. This iconic hotel marries a "bucket-list" city with world-class services and is an ideal location for your unforgettable time exploring Cairo.

Choice of the Finest ships

Locally Inspired Design

- We scoured the bazaars of Egypt and teamed up with local artisans to source the bespoke pieces that give our ships a unique degree of authenticity and elegance, such as fine Egyptian cotton, marble and hand-carved blonde wood.

The Top Decks

- No matter which ship you sail on, we made sure to create the perfect top deck oasis for sailings down the sun-drenched Nile River, complete with a plethora of comfortable chaise lounges, a turquoise tile pool and airy cabanas inspired by ancient Egyptian barges.

The Best Ships on the Nile

- With two equally luxurious Uniworld ships to choose from, including the all-suite River Tosca, your suite experience is guaranteed to have you living in a manner once reserved for queens and pharaohs.

DAY 1: Cairo 🏛️

Upon arrival to Cairo International Airport, a Uniworld representative will be on hand to greet you and escort you to the opulent Four Seasons Hotel Cairo or iconic The Nile Ritz-Carlton hotel.

DAY 2: Cairo 🏛️

The ancient quarter of Cairo is intense-the colours, the sounds, the density of people and it's likely been this way for thousands of years. Your local expert will show you a 12th-century citadel, the beautiful Alabaster Mosque and an unsurpassed collection of priceless artefacts, including mind-boggling treasures once buried with the boy king Tutankhamen. (B)

Featured Excursions: Citadel of Salah al-Din, Alabaster Mosque and Egyptian Museum.



Marvel at the brand-new Egyptian Museum

DAY 5: Luxor, Cruising the Nile River, Kom Ombo

The word "colossal" will take on a whole new meaning after today's excursion to the gigantic twin statues known as the Colossi of Memnon. And that's just the beginning you'll also visit the temple of one of Egypt's rare female pharaohs as well as the Valley of the Kings, used as a royal burial place for nearly 500 years and where the mummified remains of Tutankhamen are on display. (B, L, D)

Featured Excursions: Colossi of Memnon, Hatshepsut Temple and Valley of the Kings.

DAY 6: Kom Ombo, Cruising the Nile River, Aswan

After visiting a temple dedicated to a crocodile god today (don't miss the display of some of the 300 mummified crocs found in the local area), hop aboard a small boat for a bird-watching excursion along the Nile. (B, L, D)

Featured Excursions: Kom Ombo Temple or Life on the Nile Tour by Motorboat.



Queen Hatshepsut



Temple at Karnak, Egypt

DAY 3: Cairo, Fly to Luxor (Embark) Cruising the Nile River, Dendera

Prepare to be amazed at the legendary Temple of Karnak, a massive and absolutely astounding site, with gigantic columns, broad avenues lined with stone sphinxes and halls of truly epic proportions. This evening, you'll revel in a Welcome Reception and Dinner onboard. (B, L, WD)

Featured Excursion: Temple at Karnak.

DAY 4: Dendera, Cruising the Nile River, Luxor

Like its twin shrine, the Temple of Karnak, the Temple of Luxor stands on the site of ancient Thebes, the once flourishing capital of Egypt's New Kingdom. It was built over hundreds of years and even in ruins, it is still an extraordinary place. You'll also visit the Temple of Hathor, dedicated to the goddess of love and beauty. (B, L, D)

Featured Excursions: Temple of Hathor and Temple of Luxor.



Royal Suite - Super Ship Sphinx



Luxor Temple complex, Luxor, Egypt



Valley of the Kings, Egypt

DAY 7: Aswan

Today is an epic day, filled with wonders from start to finish. You'll visit a marvel of modern engineering-the Aswan High Dam-as well as the Unfinished Obelisk and the beautiful Philae Temple complex, which was moved from one island to another back in the 1970s. But wait, there's more. You'll also take a ride in a felucca-a traditional Egyptian sailboat-and enjoy afternoon tea at a famous hotel depicted in Agatha Christie's novel Death on the Nile. After dinner onboard this evening, you'll be treated to an enchanting Nubian show featuring traditionally attired performers, live music and dancing. (B, L, D)

Featured Excursions: Aswan High Dam, Unfinished Obelisk and Isis Temple, plus boat ride in traditional Nile River felucca and Sunset Tea at the Old Cataract Hotel Aswan.

DAY 8: Aswan, Cruising the Nile River, Edfu

Spend the day at leisure or join us for an optional excursion to see the magnificent temples of Abu Simbel. (B, L, D)

DAY 9: Esna, Cruising the Nile River, Luxor

On today's excursion, you'll learn how the Temple of Esna was buried under debris for many centuries and is one of the last great Egyptian temples ever built. Your Egyptologist guide will share all sorts of fascinating insights about this significant cultural site and show you the façade bearing the last known hieroglyphic inscriptions ever recorded in Egypt. Later, savour the Nile's majestic scenery as the ship cruises to Luxor. (B, L, D)

Featured Excursion: Temple of Khnum.

DAY 10: Luxor (Disembark), Fly to Cairo

Disembark in Luxor and transfer to the airport for your return flight to Cairo. Then, check in to your luxury hotel where you'll have time to relax before dinner. (B, D)

DAY 11: Cairo

It's a day of Bucket List Moments today as we venture to Ancient Memphis, a UNESCO World Heritage Site with a number of amazing monuments to see including the enigmatic Great Sphinx. You'll have a thrilling opportunity to view the pyramids from an up-close perspective, the only way to fully appreciate their remarkable size and grandeur. (B)

Featured Excursion: Ancient Memphis sites, including the Pyramids of Giza with small pyramid entry, the Great Sphinx and Sakkara visit

DAY 12: Depart Cairo

Check out of your hotel and transfer to the Cairo International Airport for your flight home, or extend your trip with a memorable optional extension in Jerusalem. (B)



View the pyramids from an up-close perspective



Great Sphinx, Giza



Explore with a qualified Egyptologist

— THE LUXURY —
NEW YEAR SALE EVENT
Book by 31st January

2024 Departures

Cabin Type	Was From	Now From
Royal Suite	£10,299	£9,799
Suite	£8,599	£8,099
French Balcony	£6,199	£5,699

2025 Departures

Royal Suite	£10,599	£9,539
Suite	£8,999	£8,099
French Balcony	£6,499	£5,849

Prices shown are per person guide prices based on lowest lead in rates and must always be checked before booking. Price shown based on two guests sharing a double occupancy cabin, including flights from London. Supplements may apply for regional airports and may vary on certain airlines. Day to day activities, inclusions and itinerary details are subject to change. Prices shown are correct at time of print, may fluctuate up or down throughout the year.

FOR THE LATEST OFFERS AND PRICING, ALWAYS CHECK WITH YOUR TRAVEL AGENT

RIVER HERITAGE CLUB MEMBERS

Past guests of Uniworld will receive an additional £150pp off this itinerary

Extend your Stay in Egypt

SPLENDOURS OF EGYPT & THE NILE WITH JORDAN

AMMAN TO AMMAN - 17 DAYS

For the ultimate long-haul adventure, combine our Splendours of the Nile itinerary into an 17 day experience from Amman to Cairo (or reverse). Thousands of years of history are yours to uncover as you wind your way through destinations brimming with archaeological wonders, mountainous landscapes and ancient ruins. This insightful discovery will open your eyes to the magnificence of this not-to-miss country.



2024 & 2025 Departures
For dates and pricing details contact us below

Solo Travellers
To discuss solo traveller options please contact us

EVERY LUXURY INCLUDED

- 3 nights at The St. Regis Amman hotel (or similar)
- 1 night at Mazayen Camp Wadi Rum (or similar)
- 1 night at Al Manara, a Luxury Collection Hotel (or similar)
- Breakfast daily and all service charges, taxes and portorage
- A host of immersive excursions throughout your Journey
- All transfers and transportation
- Flight between Amman and Cairo
- Services of a local host/guide
- Plus all the luxury amenities in Egypt showcased on pages 74-78

SPLENDOURS OF EGYPT & THE NILE WITH THE RED SEA

CAIRO, SHARM EL SHEIKH TO CAIRO - 16 DAYS

The Red Sea area is one of the best places in the world for diving, snorkeling and sea sports. Discover why on this post-cruise/tour extension to our Egyptian river cruises, during which you'll stay at a remarkably elegant resort in Sharm El Sheikh.



2024 & 2025 Departures
For dates and pricing details contact us below

Solo Travellers
To discuss solo traveller options please contact us

EVERY LUXURY INCLUDED

- 3 nights at the Sharm El Sheikh at Four Seasons Resort (or similar)
- 1 night at the Four Seasons Hotel Cairo at Nile Plaza (or similar)
- Breakfast daily and all service charges, taxes and portorage
- Explore Saint Catherine's Monastery, Dahab City, and Sea Scope Submarine
- All transfers and transportation
- All transfers and transportation
- Flights between Cairo and Sharm El Sheikh
- Services of a local host/guide
- Plus all the luxury amenities in Egypt showcased on pages 74-78

EVERY LUXURY INCLUDED

ON-BOARD

- Complimentary house wine, local spirits and beer served during lunch and dinner
- Best Dining Experiences on the World's Rivers
- Welcome and Farewell Gala Dinners
- Locally inspired onboard entertainment
- Sail the Nile in ultimate style and experience local life
- Free Wi-Fi access
- All on board gratuities

ON LAND

- Immersive and inspiring shore excursions
- Visit iconic sights like the Great Sphinx and Great Pyramids
- Visits to 15 UNESCO World Heritage Sites
- Visit the Temples of Karnak, Hathor and Luxor
- Explore Egypt with a qualified Egyptologist
- Airport to ship transfers
- All internal flights throughout
- Return flights from London Heathrow



Dine on-board the Aria Amazon



Birdwatching, Peru



Observation Deck - Aria Amazon

PERUVIAN AMAZON & MACHU PICCHU LUXURY EXPEDITION

Aria Amazon - Maximum Capacity: no more than 32 guests

The Amazon Rainforest, the Sacred Valley and Machu Picchu all in one trip? Do it all in high style on our most exclusive itinerary to date. You'll experience diverse landscapes from Lima to Cusco before venturing into the Amazon Rainforest for the trip of a lifetime.

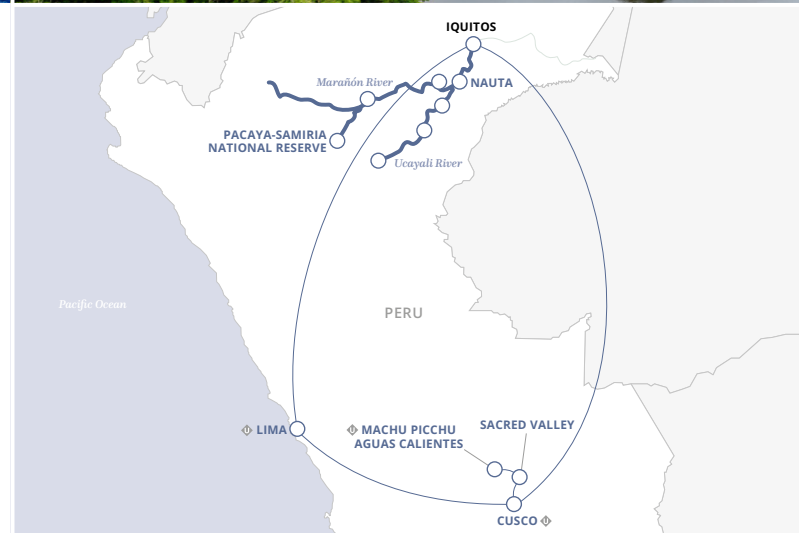

LIMA TO LIMA | DAYS: 16
1 COUNTRY | INCLUDES FLIGHTS FROM LONDON

feefo Service Rating ★★★★★ Product Rating ★★★★★

ONCE-IN-A-LIFETIME EXPERIENCES

The best of Peru

Machu Picchu

- Nestled high in the slopes of the Andes, the ruins of Machu Picchu continue to reveal the mysteries of the Inca Empire. A breathtaking, historical sight, Machu Picchu is one of the "must-see" archaeological sites in the world and a day you will always remember.

Lima

- Known as the "City of Kings," Lima was founded in 1535. A melting pot of cultures, flavours and history, this bustling metropolis has something for everyone.

Cusco

- Located in the Andes Mountains, Cusco was the heartland of the Inkan Empire. Visit vibrant markets, ceremonial fortresses and breathtaking temples.

Cruising the Amazon

Get up close with Nature

- The Amazon rainforest is abundant with exotic wildlife. Follow your guides into the jungle to enjoy an up-close look at some of the world's rarest animals, including some unforgettable skiff rides through the breathtaking scenery.

Enchanted Lake

- Sail deep into the Amazon for an evening stargazing on the "Enchanted Lake". Look up to the darkest and clearest sky you've ever seen and gaze upon a sky illuminated by thousands of stars, constellations and planets.

Birthplace of the Amazon

- Despite centuries of exploration, the Amazon River remains a fascinating destination, shrouded in mystery. Journey to where this mighty river is born, where the Ucayali and Marañón Rivers join.



Suite - Double Aria Amazon



Scan code to watch a video about this cruise

TRAVEL IN THE ULTIMATE STYLE

Stay in Peru's Finest Hotels

Country Club Lima

- Located in the prestigious San Isidro district, Country Club Lima Hotel is one of the most exclusive hotels in Lima and is renowned for its excellent service.

Palacio Del Inka

- Considered a historic landmark, Palacio del Inka is a five-centuries-old mansion located in the heart of downtown Cusco. This hotel's captivating design embraces historical aspects of our Peruvian culture while maintaining world-class luxury and modern conveniences.

Sumaq Machu Picchu Hotel

- Sumaq Machu Picchu hotel, named one of South America's best hotels by Condé Nast Traveler is located at the foot of the historic sanctuary of Machu Picchu near the beautiful Vilcanota River.

Cruising onboard the Aria Amazon

All Suite Ship

- Complete with floor-to-ceiling windows, there is no better way to experience the full view of the majestic rivers and rainforest you sail through.

Maximum of 32 Guests

- With only 16 suites onboard, this ship is the most exclusive within the Uniworld fleet. Every element has been designed to enhance your experience on the rivers you sail along, you're guaranteed to have an intimate and immersive experience.

Exceptional Dining

- Throughout your cruise, you will enjoy five-star cuisine by top Peruvian chef Pedro Miguel Schiaffino. Pedro is famous for showcasing the flavours the Amazon jungle can bring to Peruvian cuisine.

DAY 1: Lima 🏰

Upon arrival to Jorge Chávez International Airport in Lima, a Uniworld representative will be on hand to greet you and escort you to the beautiful Country Club Lima Hotel. Its charm and comfort will offer you the perfect home for your exploration of the city.

DAY 2: Lima 🏰

Known as the "City of Kings," Lima was founded in 1535. A melting pot of cultures, flavours and history, this bustling metropolis has something for everyone, and today you get to discover it all. (B, L, D)

Featured Excursion: Lima City Tour.

DAY 3: Lima, Fly to Iquitos (Nauta), Embark

You will be picked up at your hotel and taken to the airport for your flight to Iquitos. Upon your arrival at Iquitos International Airport, a Uniworld representative will be on hand to greet you and escort you to the *Aria Amazon*. In the evening, you will be welcomed with a reception dinner by Chef Pedro Miguel Schiaffino. Famous for his innovative take on Amazonian cuisine, this dinner will be bursting with flavours unique to the Peruvian Amazon. (B, L, D)

Featured Excursion: Marañón River skiff ride.



DAY 6: Nauta

One of the oldest inhabited areas in the Peruvian Amazon, Nauta is nestled between the Marañón and Ucayali Rivers. You'll explore the town's market, which is full of fresh fish, fruits and vegetables. From there, it's a short journey to the birthplace of the Amazon River. (B)

Featured Excursions: Nauta market visit and Birthplace of the Amazon.

DAY 7: Ucayali River, Pacaya River

Experience life as an Amazon River dweller as you cruise along the Ucayali River. Search for the famous pink dolphins and other wildlife lurking just beyond the river. Once the sun sets, we'll take to the Pacaya River, on the lookout for nocturnal beasts. (B, L, D)

Featured Excursions: Skiff tour along the Ucayali River and Evening skiff tour on the Pacaya River.



DAY 4: Yanayacu-Pucate River, Marañón River

Your day starts at the Pacaya-Samiria National Reserve, the second largest protected natural area in Peru. Kayak, canoe and swim in the black waters of the Yanayacu-Pucate River. In the afternoon, learn about traditional customs of the area at a remote village along the Marañón River. Once the sun sets, we'll gaze at the night sky, where you'll have a crystal-clear view of planets and constellations. (B, L)

Featured Excursions: Village Tour and Yanayacu-Pucate River Excursion.

DAY 8: Pacaya River, Ucayali River, Tapiche River

Your day starts early today with a skiff excursion along the Pacaya River, where you'll venture into the rainforest to see some wildlife. Following lunch, you'll participate in a paiche fishing demonstration. The paiche is the second largest fish in the world. We'll end the day watching for the pink river dolphins on the Ucayali River. (B, L, D)

Featured Excursions: Skiff tour on the Pacaya River, Paiche fishing demonstration or Skiff tour on the Ucayali River.



DAY 5: Samiria River, Nauta Caño (Amazonian Natural Park)

Today we're exploring the vibrant wildlife and lush greenery thriving in the Amazon. Your naturalist guide will teach you all about the diverse flora and fauna unique to the region before setting off on a guided jungle walk. You'll finish the day stargazing on the "Enchanted Lake." (B, L, D)

Featured Excursions: Stargazing on the "Enchanted Lake" and Samiria River & jungle walk.



DAY 9: Clavero Lake, San Jose de Sarapanga Forest

Spend the morning jungle walking, canoeing, kayaking or swimming on the black water Yarapa River or Clavero Lake. In the afternoon, see the unbelievable giant water lilies of the San Jose de Sarapanga forest. (B, L, D)

Featured Excursions: Yarapa River & Clavero Lake and Jungle walk in the San Jose de Sarapanga forest.

DAY 10: Nauta (Iquitos), Disembark, Fly to Cusco, Urubamba (The Sacred Valley)

Take a morning walk through the town of Nauta before disembarking the *Aria Amazon*. Your guide will take you on a few excursions on your way to the Iquitos airport for your

flight to Cusco. Once you've landed in Cusco, you will be taken to the Tambo del Inka hotel in the Sacred Valley. (B, L, D)

Featured Excursions: Nauta town visit, Manatee Rescue Centre and San Juan craft market.

DAY 11: Urubamba (The Sacred Valley)

Enjoy this day of leisure to get the most out of your stay at the wonderful Tambo del Inka. Treat yourself to a relaxing service at their Kallpa Spa, considered one of the best in the country, take a dip in the heated pool or savour delicious Andean cuisine. Situated in the heart of the Sacred Valley, the Tambo del Inka is also the perfect location from which to head out on your own to explore

the incredible nature, cities and historical sites available nearby. (B, L, D)

DAY 12: Urubamba, Ollantaytambo, Aguas Calientes (Machu Picchu)

Today you will explore the heartland of the Inka Empire, known as the Sacred Valley. Your guide will take you to Moray and Ollantaytambo, two historic sights of significant importance. You'll experience the unique way of living in the Sacred Valley as you meet locals. We finish the day with a train ride to Aguas Calientes, the small villages nestled at the bottom of Machu Picchu. (B, L, D)

Featured Excursions: Moray-Agricultural Terraces & Weaving and Ollantaytambo Family Home Tour with Picnic Lunch

DAY 13: Aguas Calientes (Machu Picchu), Cusco

A breathtaking, historical sight, Machu Picchu is one of the “must-see” archaeological sites in the world. This remarkable Inkan Empire site was never found by the Spaniards and was rediscovered during the 20th century. Today, archaeologists continue to excavate this ancient city. While many mysteries still surround it, Machu Picchu tells a story of a history that goes back thousands of years. Following your day at Machu Picchu, you will take a train to Ollantaytambo and then a motor coach will take you to the Palacio del Inka hotel in Cusco. (B, L, D)

Featured Excursion: Machu Picchu.

DAY 14: Cusco

Located in the Andes Mountains, Cusco was the heartland of the Inkan Empire. Today, you will explore all the wonders of this city as you admire the cobblestone streets, colourful textiles and art galleries. A perfect blend of ancient Andean cultures with Spanish colonial splendour, Cusco is not to be missed. Overnight, you will stay in the Palacio del Inka hotel. (B, L, D)

Featured Excursion: Cusco city tour.

DAY 15: Cusco, Fly to Lima

We're headed back to Lima today. After a brief walk around town, you'll head to the Wyndham Costa del Sol Lima Airport hotel. (B.)

DAY 16: Lima

Your majestic Peru adventure ends this morning. Your guide will walk you from the Wyndham Costa del Sol Lima Airport hotel to the Lima International Airport to begin your journey home.



Machu Picchu



The city of Cusco



Discover the mysterious ollantaytambo

— THE LUXURY —
NEW YEAR SALE EVENT
 Book by 31st January

Extend your Stay in South America

NEW FOR 2024: RIO DE JANEIRO & IGUAZU FALLS

5-DAY PRE-CRUISE/TOUR EXTENSION

On this pre-cruise/tour extension in conjunction with our Peruvian River cruises discover the rich culture of Rio de Janeiro, Brazil & experience the majestic Iguazu Falls from both the Brazilian and Argentinian sides.



Iguazu Falls



Belmond Copacabana Palace

EVERY LUXURY INCLUDED

ON-BOARD

- Complimentary house wine, local spirits and beer served at select times.
- Five-star cuisine with menu designed by top chef Pedro Miguel Schiaffino.
- Stay onboard the 16 suite ship Aria Amazon
- Welcome and Farewell Gala Dinners
- Locally inspired onboard entertainment
- Sail Peru in ultimate style and experience local life
- Free Wi-Fi access
- All on board gratuities

ON LAND

- Immersive and inspiring shore excursions.
- Visit Macchu Picchu, the largest religious complex in the world
- Visits to 2 UNESCO World Heritage Sites
- Stay in the finest hotels Peru has to offer
- Stroll through the mighty Amazon Rainforest
- Airport to ship transfers
- All internal flights throughout
- Return flights from London Heathrow

2024 Departures		
Cabin Type	Was From	Now From
Suite	£11,099	£10,099
2025 Departures		
Suite	£13,099	£11,789

Prices shown are per person guide prices based on lowest lead in rates and must always be checked before booking. Price shown based on two guests sharing a double occupancy cabin, including flights from London. Supplements may apply for regional airports and may vary on certain airlines. Day to day activities, inclusions and itinerary details are subject to change. Prices shown are correct at time of print, may fluctuate up or down throughout the year.

FOR THE LATEST OFFERS AND PRICING, ALWAYS CHECK WITH YOUR TRAVEL AGENT

RIVER HERITAGE CLUB MEMBERS
 Past guests of Uniworld will receive an additional £250pp off this itinerary



2024 & 2025 Departures
 For dates and pricing details contact us below

Solo Travellers
 To discuss solo traveller options please contact us

EVERY LUXURY INCLUDED

- 2 nights at the Belmond Copacabana Palace (or similar) - Rio de Janeiro
- 2 nights at the Belmond das Cataratas (or similar) - Iguazu Falls
- Breakfast daily and all service charges, taxes and portage
- Panoramic tour of Downtown Rio de Janeiro, visit Sugar Loaf Mountain, & Christ the Redeemer Statue, Explore Iguazu National Park on both the Brazilian and Argentinian sides
- All transfers and transportation
- Services of a local guide*

*Local guides will differ between Rio de Janeiro & Iguazu Falls; local guide will not join guests during flights.

MEET OUR FLEET OF SHIPS

And discover the inspiration behind each floating boutique hotel

Every Uniworld ship is one-of-a-kind, complete with destination inspired décor depending on the rivers they sail upon. Get to know every ship in our fleet, plus discover the design inspiration behind each.



S.S. LA VENEZIA

Sailing on our 8- day Venice & The Jewels of Veneto itinerary

See page 88



S.S. BON VOYAGE

Sailing on our 8- day Brilliant Bordeaux itinerary

See page 90

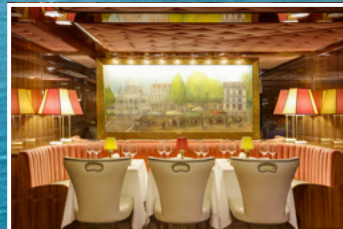

S.S. JOIE DE VIVRE

Sailing on our 8- day Paris & Normandy itinerary

See page 92



MEKONG JEWEL

Sailing on our 17- day Timeless Wonders of Vietnam, Cambodia & the Mekong itinerary

See page 98



GANGES VOYAGER II

Sailing on our 15- day India's Golden Triangle & the Sacred Ganges itinerary

See page 99



S.S. SPHINX

Sailing on our 12- day Splendours of Egypt itinerary

See page 100

S.S. LA VENEZIA

TRANSFORMATION	2020
INAUGURATION	2003
RIVERS	Venice Lagoon
GUESTS	126
STAFF	44
GRAND SUITE	2 (302 ft ²)
SUITE	4 (214 ft ²)
FRENCH BALCONY	14 (151 ft ²)
DELUXE	36 (151 ft ²)
CLASSIC	7 (151 ft ²)
LENGTH	361 ft
WIDTH	37.5 ft



The *S.S. La Venezia* offers a vibrant yet sophisticated discovery of Venice and its surrounding islands, and stands witness to Italy's incomparable architecture, artistic contributions, world-renowned fashion and famed cuisine. The redesign of this Super Ship drew influence from the fine Fortuny fabrics displayed prominently onboard. Murano glass, gilded accents and artistic etched elements pay homage to popular Venetian aesthetics of the early 20th century.

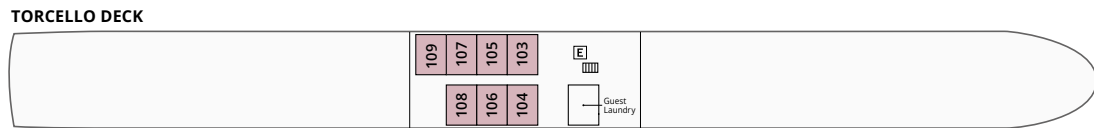
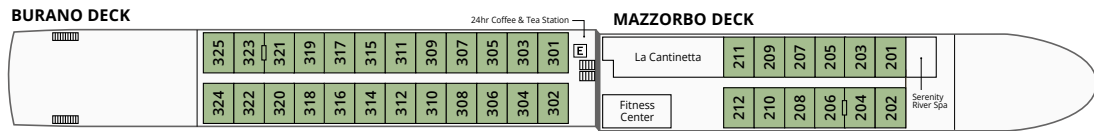
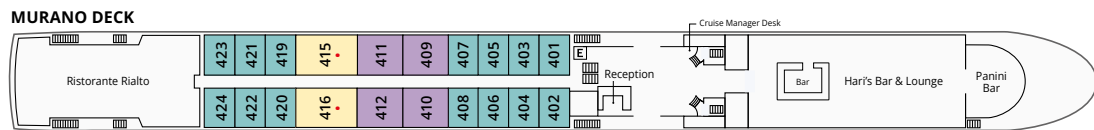
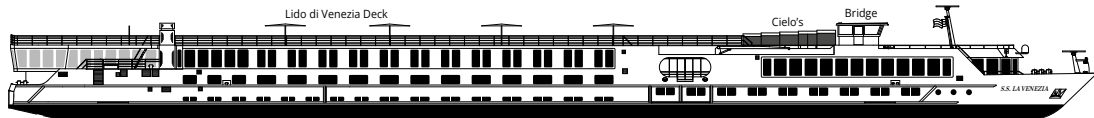

Legend: Grand Suite (Yellow), Suite (Purple), French Balcony (Teal), Deluxe (Green), Classic (Pink), Elevator (E), Triple accommodation available (Red dot).

Note: Suites on the Murano Deck have French balconies. Designated suites provide triple-accommodation options. Designated adjoining staterooms are available.

S.S. SÃO GABRIEL

INAUGURATION	2021
RIVER	Douro
GUESTS	100
STAFF	37
GRAND SUITE	4 (307 ft ²)
SUITE	12 (220 ft ²)
FRENCH BALCONY	20 (156 ft ²)
DELUXE	10 (156 ft ²)
CLASSIC	4 (135 ft ²)
LENGTH	262 ft
WIDTH	37 ft

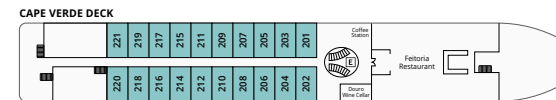
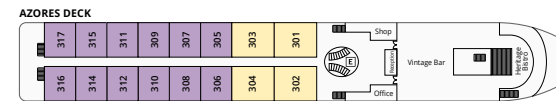
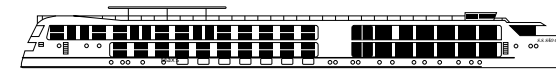

Legend: Grand Suite (Yellow), Suite (Purple), French Balcony (Teal), Deluxe (Green), Classic (Pink), Elevator (E).

The *S.S. São Gabriel* embodies the spirit of Portugal. Light, airy décor throughout the ship mimics the sun-drenched nature of this fascinating country, while pops of colour emphasise its vivacity and brilliant blues and greens, reflect the lush Douro River. To complete this work of art-Portugal's signature hand-made blue and white ceramic azulejos tilework can be found throughout the ship.

This chic Super Ship offers 4 different venues serving unlimited drinks and locally-inspired cuisine, a pool for relaxing on the sundeck while you sail past gorgeous scenery, and an entire top deck of butler-serviced suites.

Note: While the *S.S. São Gabriel* is the most luxurious ship on the Douro River, its amenities may differ from Uniworld company-owned ships.

S.S. BON VOYAGE

TRANSFORMATION	2019
INAUGURATION	2006
RIVERS	Dordogne, Garonne
GUESTS	124
STAFF	50
GRAND SUITE	2 (280 ft ²)
SUITE	2 (210 ft ²)
FRENCH BALCONY	22 (140 ft ²)
DELUXE	30 (151 ft ²)
CLASSIC	6 (151 ft ²)
LENGTH	361 ft
WIDTH	37.5 ft



The *S.S. Bon Voyage* is designed to seamlessly immerse guests in the culture, art and wine of the France. A stunning lobby clad in polished wood, subtle brass details and a hand-crafted balustrade lend uncommon elegance, while the stylish sundeck boasts the river cruise industry's first and only infinity pool. An onboard bar lounge, Le Salon du Champagne, is resplendent in chic emerald tones with a design inspired by Yves Saint Laurent's personal abode, Villa Majorelle. In addition to the public spaces, the *S.S. Bon Voyage* features four spacious suites, and every stateroom features an exquisite marble bathroom.

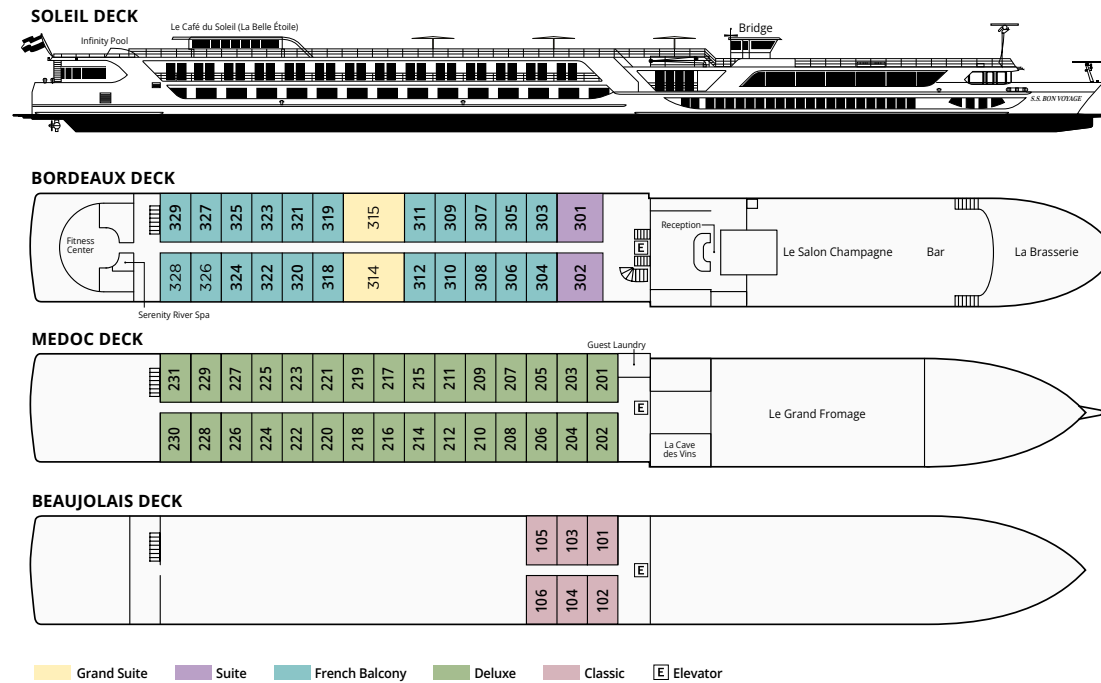

Note: All suites on the Victor Hugo Deck have French balconies. Designated suites provide triple-accommodation options.

S.S. CATHERINE

INAUGURATION	2017
RIVERS	Rhône, Saône
GUESTS	159
STAFF	56
GRAND SUITE	1 (410 ft ²)
SUITE	5 (305 ft ²)
DELUXE FRENCH BALCONY	23 (194 ft ²)
FRENCH BALCONY	38 (194 ft ²)
CLASSIC	12 (162 ft ²)
LENGTH	443 ft
WIDTH	37.5 ft



Uniworld is committed to building a fleet of ships that represents the absolute best in luxury river cruising, combining quality craftsmanship with high-tech innovations and custom-designed interiors. The *S.S. Catherine* continues this proud tradition of excellence with sumptuous materials and meticulous attention to detail. The vessel's exquisite interiors include a two-story lobby with a specially commissioned Murano glass chandelier and whimsical life-size glass horse by Pino Signoretto.

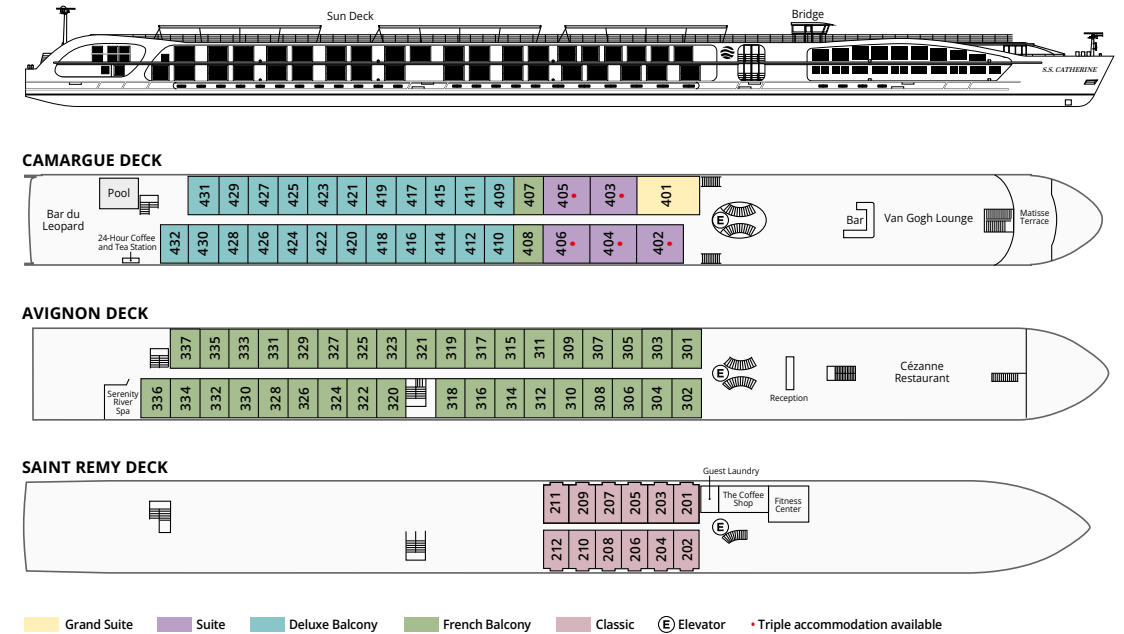

Note: Deluxe balcony staterooms and suites on the Camargue Deck have open-air balconies that, with a touch of a button, will raise the glass to create a completely enclosed conservatory. Designated suites provide triple-accommodation options.

S.S. JOIE DE VIVRE

INAUGURATION	2017
RIVER	Seine
GUESTS	128
STAFF	54
GRAND SUITE	2 (410 ft ²)
SUITE	8 (260 ft ²)
DELUXE FRENCH BALCONY	16 (194 ft ²)
FRENCH BALCONY	29 (194 ft ²)
CLASSIC	9 (162 - 180 ft ²)
LENGTH	410 ft
WIDTH	37.5 ft



S.S. Joie de Vivre brings the “joy of living” to the rivers of France. Step aboard your floating pied-à-terre in France, featuring handcrafted furniture and fine antiques, original artwork, and signature accents inspired by 20th-century Parisian design blended seamlessly with modern conveniences. The Super Ship’s attention to detail is unmatched, with fabrics and upholstery from the Tollman’s historical archives, as well as some of the most esteemed design houses in Europe.

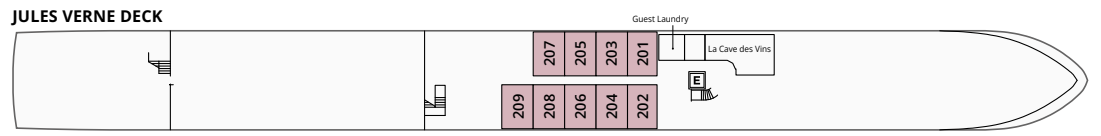
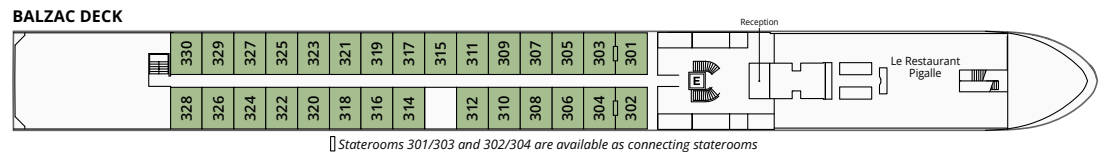
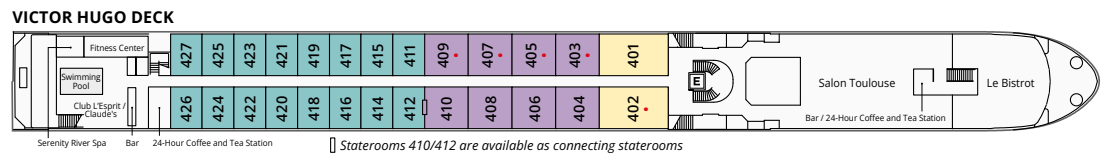
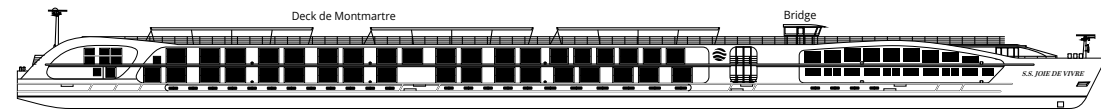

Grand Suite Suite Deluxe French Balcony French Balcony Classic Elevator Triple accommodation available

Note: All suites on the Victor Hugo Deck have French balconies. Designated suites provide triple-accommodation options. Designated adjoining staterooms are available.

S.S. MARIA THERESA

INAUGURATION	2015
RIVER	Danube
GUESTS	150
STAFF	57
GRAND SUITE	1 (410 ft ²)
SUITE	10 (305 ft ²)
DELUXE FRENCH BALCONY	18 (194 ft ²)
FRENCH BALCONY	36 (194 ft ²)
CLASSIC	10 (162 ft ²)
LENGTH	443 ft
WIDTH	37.5 ft



This splendidly elegant ship cruises along the Danube River boasting ultra-luxurious accommodations fit for Empress Maria Theresa herself. As a tribute to the only female ruler in the House of Habsburg, a 10-foot-tall, specially commissioned portrait namesake hangs in the two-story foyer. Travel like royalty surrounded by opulent silk-clad walls, a Murano glass chandelier in the lobby, eye-catching patterns in every room, hand-painted coronets and a mosaic-tiled enclosed swimming pool.

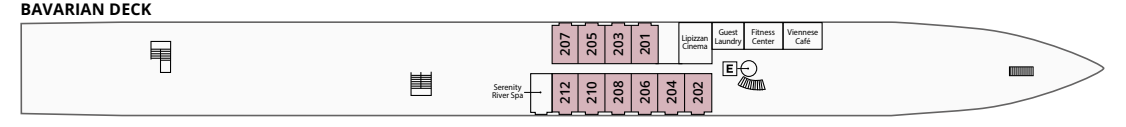
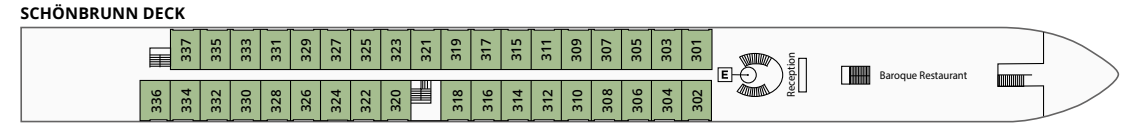
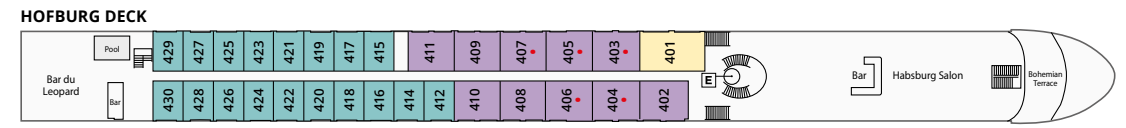
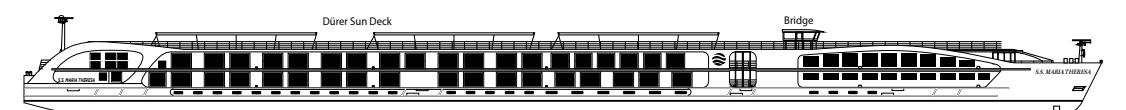

Grand Suite Suite Deluxe Balcony French Balcony Classic Elevator Triple accommodation available

Note: Staterooms and suites on the Hofburg Deck have open-air balconies that, with the touch of a button, will raise the glass to create a completely enclosed conservatory. Designated suites provide triple-accommodation options.

S.S. BEATRICE

TRANSFORMATION	2018
INAUGURATION	2009
RIVER	Danube, Main, Rhine
GUESTS	152
STAFF	58
ROYAL SUITE	2 (390 ft ²)
GRAND SUITE	2 (310 ft ²)
SUITE	12 (225 ft ²)
DELUXE FRENCH BALCONY	13 (150 ft ²)
FRENCH BALCONY	37 (150 ft ²)
CLASSIC	10 (150 ft ²)
LENGTH	430 ft
WIDTH	37.5 ft



This jewel of a ship graces the waters of the Danube River, boasting splashes of nautical hues, a stunning lobby featuring elegant mirrors, marble floors, a white Murano chandelier and a grand staircase made of nickel and iron. The design inspirations include 14th-century Chinese porcelain and Dutch Delftware. *S.S. Beatrice* creates enhanced dining and culinary experiences by offering four unique venues, all inspired by famous Austrian composers.

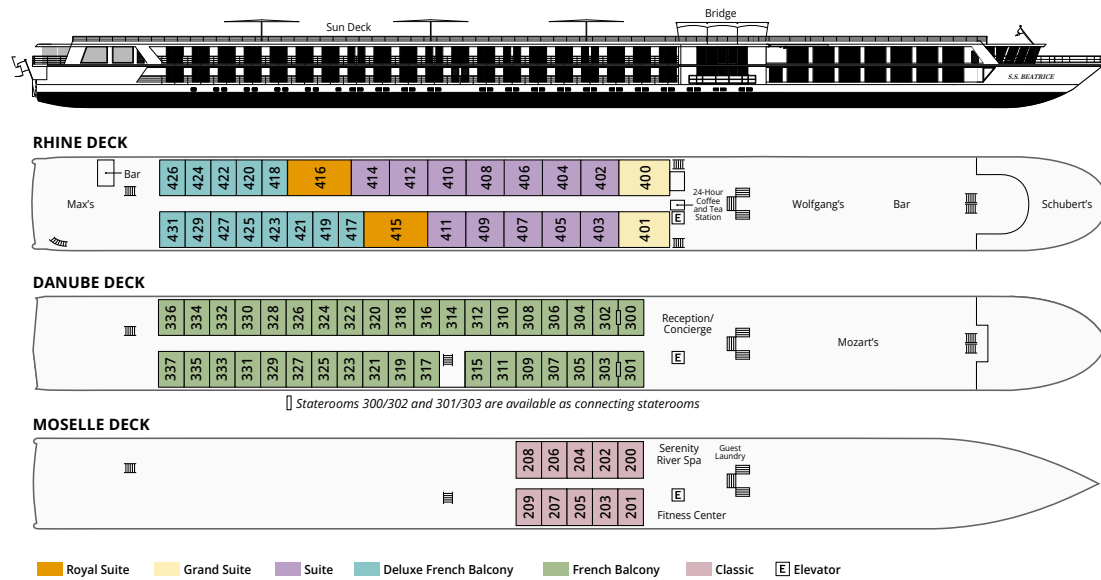

Note: All suites on the Rhine Deck have French balconies. Designated adjoining staterooms are available.

RIVER QUEEN

TRANSFORMATION	2010
INAUGURATION	1999
RIVERS	Main, Moselle, Rhine
GUESTS	128
STAFF	41
SUITE	4 (215 ft ²)
FRENCH BALCONY	16 (151 ft ²)
DELUXE	37 (151 ft ²)
CLASSIC	7 (151 ft ²)
LENGTH	361 ft
WIDTH	37.5 ft



Embrace the royal treatment as you set sail on one of the most classic and unique ships on Europe's waterways. The *River Queen* has an exterior resembling the steamships of the 1930s and an elegant Art Deco interior. With a white and blue colour scheme, richly decorated fabrics, the only functioning fireplace on the rivers and original art by Henri de Toulouse-Lautrec and Georges Goursat, you are sure to enjoy the views inside and out.

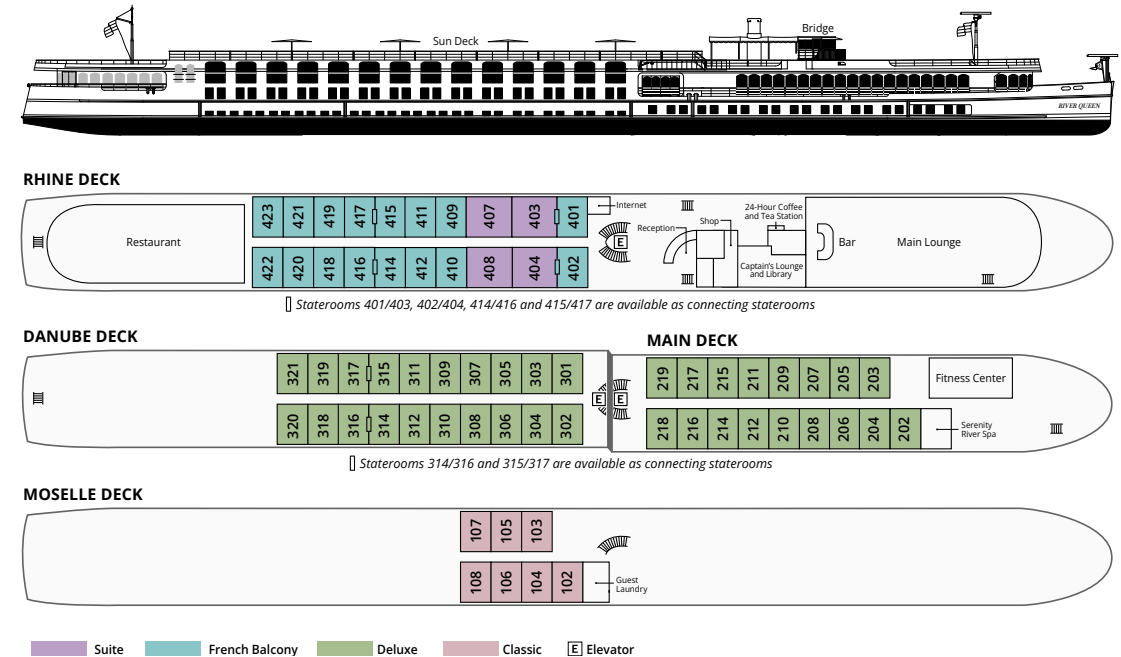

Note: Suites on the Rhine Deck have French balconies. Designated adjoining staterooms are available.

S.S. ANTOINETTE

INAUGURATION	2011
RIVER	Rhine
GUESTS	152
STAFF	59
GRAND SUITE	1 (391 ft ²)
SUITE	8 (294 ft ²)
DELUXE FRENCH BALCONY	20 (196 ft ²)
FRENCH BALCONY	33 (196 ft ²)
CLASSIC	14 (163 ft ²)
LENGTH	443 ft
WIDTH	37.5 ft



The luxurious décor of the 443-foot, 152-passenger *S.S. Antoinette*-Uniworld's first Super Ship-features fine Brazilian marble on the walls and floors, a 19th-century Venetian glass mirror, a stylish Bar du Leopard with full-service bar, and an onboard cinema. The two-story foyer boasts a 10-foot blue Strauss Baccarat chandelier with huge sapphires-a stunning piece that once hung in New York's famous Tavern on the Green-and a collection of original artwork is displayed throughout the ship.

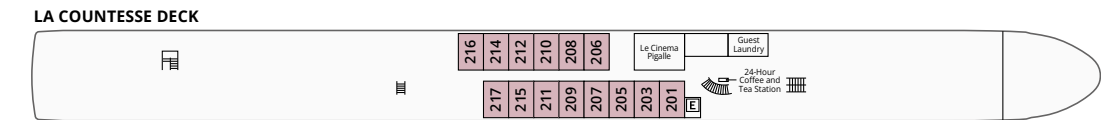
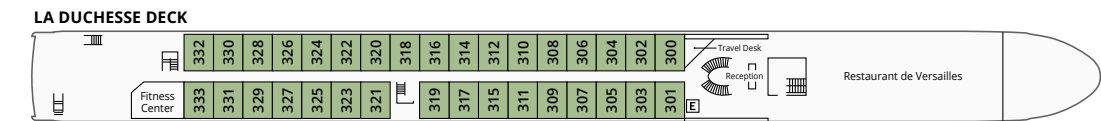
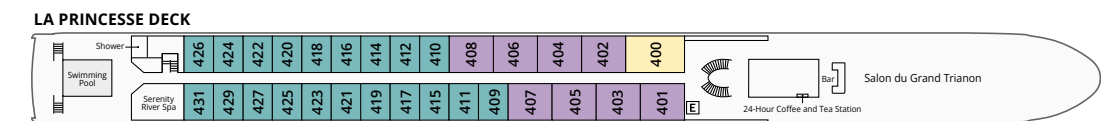
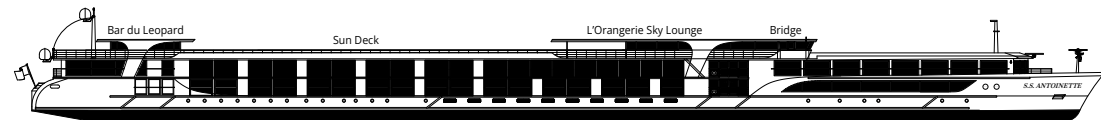

Legend: Grand Suite (Yellow), Suite (Purple), Deluxe Balcony (Teal), French Balcony (Green), Classic (Pink), [E] Elevator

Note: Staterooms and suites (with the exception of the Grand Suite and Suites 402 & 403, which have been gorgeously redesigned) on *La Princesse Deck* have open-air balconies that, at the touch of a button, will raise the glass to create a completely enclosed conservatory.

S.S. VICTORIA

INAUGURATION	New for 2024!
RIVER	Rhine, Moselle
GUESTS	110
STAFF	41
ROYAL SUITE	2 (506 ft ²)
SUITE	16 (253 ft ²)
SIGNATURE FRENCH BALCONY	20 (253 ft ²) 1 (237 ft ²)
DELUXE FRENCH BALCONY	8 (188 ft ²)
FRENCH BALCONY	8 (188 ft ²)
LENGTH	442.5 ft
WIDTH	37.5 ft

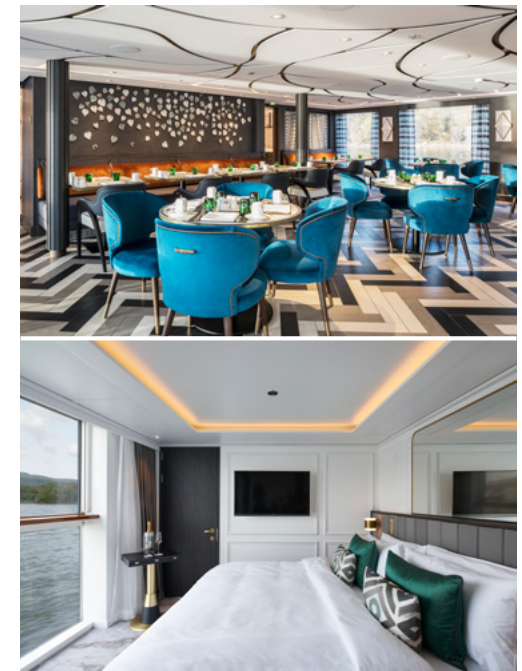

Like her sister ship, the *S.S. Elisabeth*, the *S.S. Victoria* joins our European fleet with an ambiance of contemporary luxury. This ship brings the largest suites on the rivers of Europe to our fleet, boasting two Royal Suites that offer an incredible 506 square feet each. Guests can even reserve the adjoining standard Suite next door to create a 759 square foot suite with two bedrooms connected by a separate living room

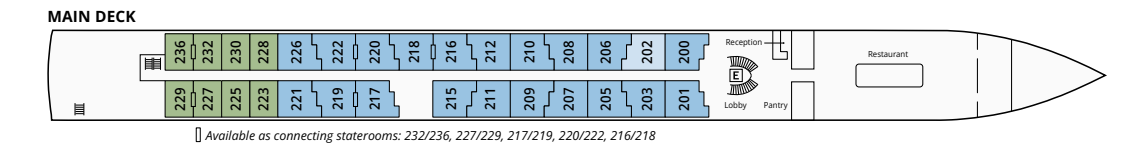
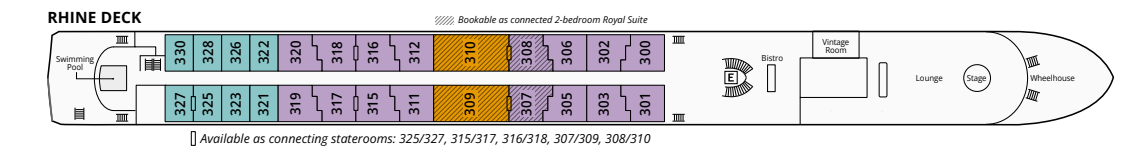
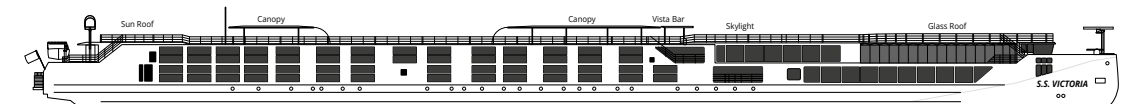

Legend: Royal Suite (Orange), Suite (Purple), Deluxe French Balcony (Teal), Signature French Balcony (Blue), French Balcony (Green), [E] Elevator

Note: Stateroom 202 is 16 ft² smaller than the other Signature French Balcony staterooms.

MEKONG JEWEL

INAUGURATION	2020
RIVER	Mekong
GUESTS	68
STAFF	51
ROYAL SUITE	2 (924 ft ²)
GRAND SUITE	2 (551 ft ²)
SUITE (BALCONY)	18 (339 ft ²)
SUITE (FRENCH BALCONY)	12 (339 ft ²)
LENGTH	262 ft
WIDTH	42 ft

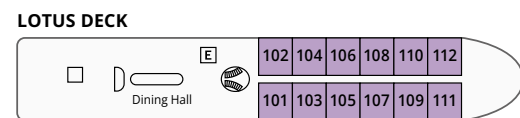
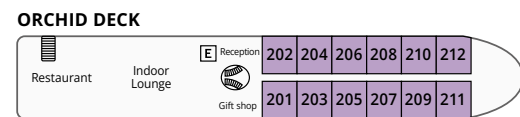
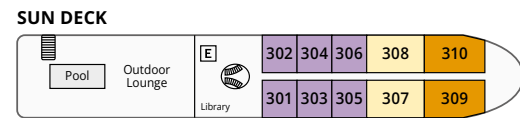
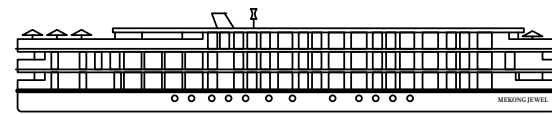

 Royal Suite
 Grand Suite
 Suite
 E Elevator

Experience the diverse cultures and uncharted beauty of the Mekong River on a spectacular new Super Ship, *Mekong Jewel*. What has long been the lifeblood of Southeast Asia, the Mekong River connects six countries and offers an enthralling look at the long and glorious histories of Vietnam and Cambodia.

This incredibly spacious, multistory ship will have you charmed by your surroundings from the moment you step onboard. The all-suite *Mekong Jewel* is made of sustainable and eco-friendly materials and features artwork inspired by the landscapes of Vietnam and Cambodia, beautiful indoor and outdoor lounges, a pool, two dining venues and a wellness centre complete with a nail and hair bar. An experience like no other awaits you on the newest ship to grace the Mekong.

Note: Suites on the Sun Deck and Orchid Deck have private open-air balconies. While the *Mekong Jewel* is a beautiful and luxurious ship, its amenities may differ from those of a Uniworld company-owned ship.

GANGES VOYAGER II

INAUGURATION	2016
RIVER	Ganges
GUESTS	56
STAFF	36
MAHARAJA SUITE	1 (400 ft ²)
VICEROY SUITE	2 (360 ft ²)
HERITAGE SUITE	2 (280 ft ²)
COLONIAL SUITE	13 (261 ft ²)
SIGNATURE SUITE	10 (261 ft ²)
LENGTH	185 ft
WIDTH	41 ft

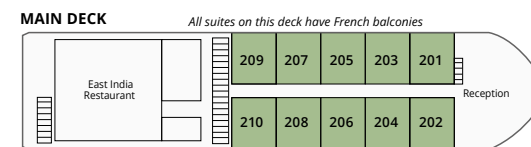
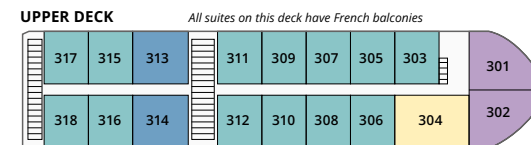
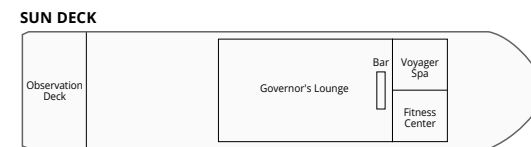
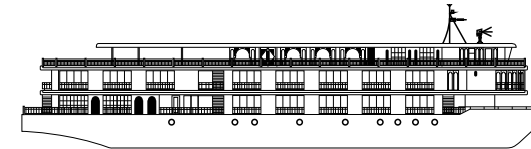

 Maharaja Suite
 Viceroy Suite
 Heritage Suite
 Colonial Suite
 Signature Suite

The ship's spacious, high-ceilinged suites are a serene sanctuary, with beautiful hand-painted murals and all the comforts of a five-star hotel. All suites have a cosy sitting area and a French balcony with floor-to-ceiling glass doors. A bed dressed in soft linens, with a choice of pillows. Your roomy bathroom has a rain shower, comfy robes and slippers, and spa-quality bath products. Other high-end amenities include a generous amount of closet space, under-bed storage, a flat-screen television with a wide selection of on-demand movies, individual climate control, bottled water replenished daily, fresh fruit and flowers upon arrival, makeup mirrors and universal electrical plugs.

Note: While the *Ganges Voyager II* is a beautiful and luxurious ship, its amenities may differ from those of a Uniworld company-owned ship. Maharaja, Viceroy and Heritage Suites have fixed beds that cannot be separated.

S.S. SPHINX

INAUGURATION	2021
RIVER	Nile
GUESTS	84
STAFF	60
ROYAL SUITE	4 (495 ft ²)
GRAND SUITE	20 (430 ft ²)
SUITE	2 (344 ft ²)
DELUXE FRENCH BALCONY	2 (344 ft ²)
FRENCH BALCONY	14 (233 ft ²)
LENGTH	235 ft
WIDTH	48.5 ft

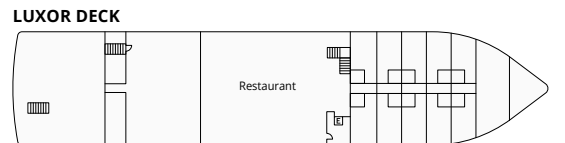
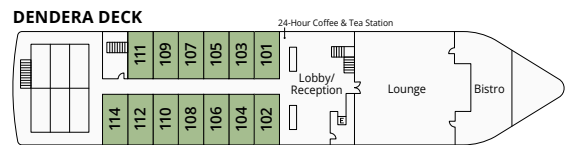
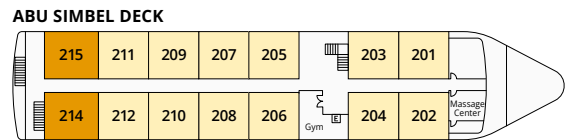
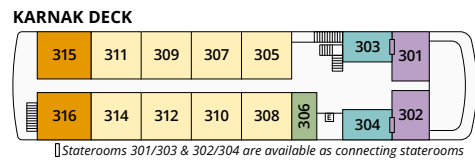
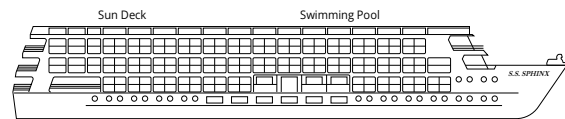

The *S.S. Sphinx* offers two gourmet dining venues, massage room, swimming pool, 26 gorgeously appointed suites and 16 stunning French balcony staterooms, not to mention, sweeping views of the longest river in the world. This Super Ship offers an immersive onboard experience, with bespoke décor by local artisans and materials sourced regionally -such as fine Egyptian cottons, marble and hand-carved blonde wood-to highlight Egyptian craftsmanship while minimising our carbon footprint.

Capturing the essence of the Great Sphinx of Giza, *S.S. Sphinx* will steer you to numerous bucket-list destinations, filling you with endless wonder and intrigue as you sail past manmade marvels, wonders of the world and ancient temple complexes.

Note: All staterooms and suites onboard have French balconies. While the *S.S. Sphinx* is a beautiful and luxurious ship, its amenities may differ from those of a Uniworld company-owned ship. Designated adjoining staterooms available for 301/303 and 302/304.

ARIA AMAZON

INAUGURATION	2011
RIVERS	Marañón, Ucayali
GUESTS	32
STAFF	27
SUITE	16 (250 ft ²)
LENGTH	147 ft
WIDTH	29.5 ft

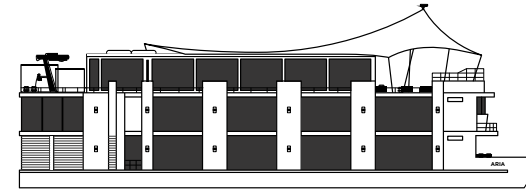

OBSERVATION DECK

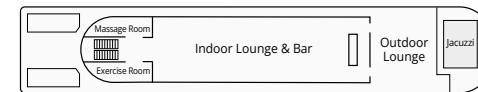

SECOND DECK

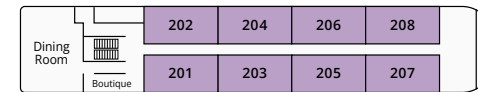

FIRST DECK

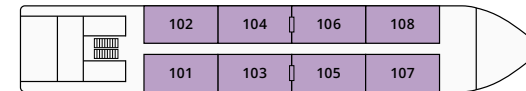

|| Suites 103/105 and 104/106 are available as connecting suites

■ Suite



Designed to explore the heart of the Peruvian Amazon in luxury and comfort, the *Aria Amazon* is an all-suite ship with floor-to-ceiling windows, giving you a full view of the majestic rivers and rainforest. The top deck features a jacuzzi, indoor lounge & bar and an outdoor observation deck.

With all-inclusive amenities and five-star cuisine by top chef Pedro Miguel Schiaffino, this luxurious ship is guaranteed to give you an intimate and immersive experience.

Note: While the *Aria Amazon* is a beautiful and luxurious ship, its amenities may differ from those of a Uniworld company-owned ship. Designated adjoining staterooms are available.

UNIWORLD®

BOUTIQUE RIVER CRUISES



**FOR THE LATEST PRICING INFORMATION OR TO BOOK,
PLEASE CONTACT YOUR PREFERRED TRAVEL AGENT**

See Uniworld.com for full terms and conditions.

Uniworld Is a Registered Company Of The Travel Corporation UK Ltd - Travel House Rue Du Manoir St Peter Port Guernsey GY1 2JH

